

# NIAR

## FORMAS



#vempraniar

A **NIAR FORMAS** é uma empresa especializada há 12 anos na fabricação de fôrmas e máquinas para facilitar no processo de produção dos artefatos de cimento. Somos fabricantes também de peças técnicas para outros segmentos. Garantimos qualidade e preço justo na fabricação de suas peças. Conheça um pouco mais sobre nossa linha de produtos.

**VOCÊ TEM A IDEIA, NÓS TEMOS O PRODUTO PARA TORNÁ-LA EM REALIDADE.**

# MÁQUINAS

## MÁQUINA DOSADORA

Máquina semi-automática/manual para produção de piso intertravado, sextavado, lajotas, tátil, meio fio, guia de rua, pisantes e elementos vazados.

Capacidade de produção: 30 a 85 M<sup>2</sup> por hora, variando conforme modelo a ser produzido. Obs: capacidade de traço e formas.

Vibração elétrica, voltagem 220/380V trifásico.

### Por que usar esse equipamento?

- Produz mais de 20 modelos de pedras;
- Aumento na produtividade;
- Redução do custo com mão de obra;
- Agrega a qualidade ao seu produto (acabamento e dureza);
- Padronização no processo de enchimento e vibração;
- Equipamento de fácil instalação, operação e segurança (plug play).
- Treinamento e acompanhamento técnico especializado.



# MÁQUINAS

## MÁQUINA DESENFARMADORA

NF 51

Máquina semi-automática desenformadora para pisos intertravado, sextavado, lajotas, tátil, elementos vazados e outros.

- Produção de até 50 m<sup>2</sup> por hora.
- Vibração elétrica, voltagem 220/380V trifásico

Por que usar esse equipamento?

- Desenforma vários modelos de pisos/pedras;
- Aumento na produtividade;
- Redução do custo com mão de obra;
- Agregando qualidade ao seu produto;
- Padronização e evita a quebra de formas e pedras;
- Equipamento de fácil instalação, operação e segurança. (plugplay)
- Treinamento e acompanhamento técnico especializado.



## FUNIL/SILO DOSADOR

NF 132

NF 206

Funil/silo dosador semi-automática ou mesas vibratórias.

Para produção de pisos intertravado, sextavado, lajotas, tátil, elementos vazados e blocos.

Por que usar esse equipamento?

- Capacidade do funil 350kg
  - Aumento na produtividade;
  - Redução do custo com mão de obra;
  - Agregando qualidade ao seu produto;
  - Padronização no processo de alimentação do processo produtivo pisos/blocos;
  - Equipamento de fácil instalação, operação e segurança.
- (Plugplay)



# MESA VIBRATÓRIA NIAR FORMAS

Equipamento desenvolvido para aprimorar o processo produtivo de pré moldados de concreto, fabricação de pisos Inter travado, sextavado, lajotas, tátil, elementos vazados e blocos.

Vibração elétrica, voltagem 220/380V trifasico  
Capacidade de carga de 300 até 350kg.

**Vantagens na utilização deste equipamento:**

- Fácil manuseio;
- Melhor acabamento e resistência nas peças produzidas;
- Equipada com motovibrador de alta performance, trifásico ou monofásico;
- Máquina sai de fábrica, regulada, testada e pronta para uso.
- Equipamento de fácil instalação, operação e segurança. (Plugplay)



# KIT FORMA METÁLICA

## Kit Bloco Com Fundo Estrutural Ombro

Ref: NF 210

1 tampa para desenformar

1 caixa

1 fundo

Medidas: 14x19x39

parede estrutural de 3cm



## Kit Bloco Canaleta Estrutural

Ref: NF 222

1 tampa para desenformar

1 caixa

1 fundo

Medidas: 14x19x39

parede estrutural de 3cm



## Kit Bloco Vazado Estrutural Ombro

Ref: NF 212

1 tampa para desenformar

1 caixa

1 fundo

Medidas: 14x19x39

parede estrutural de 3cm

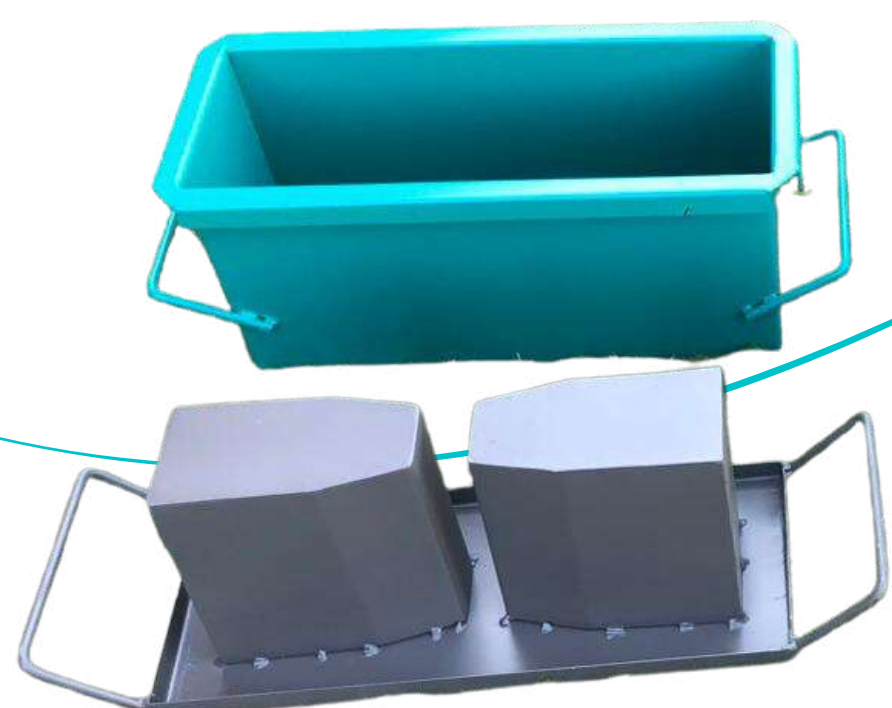

# KIT FORMA METÁLICA

## Kit Bloco Vedação Vazado

Ref: NF 220

1 tampa para desenformar

1 caixa

1 fundo

Medidas: 14x19x39

parede estrutural de 2cm

## Kit Bloco Vedação Com Fundo

Ref: NF 218

1 tampa para desenformar

1 caixa

1 fundo

Medidas: 14x19x39

parede estrutural de 2cm

## Kit Bloco Estrutural Meio Bloco Com Fundo

Ref: NF 214

1 tampa para desenformar

1 caixa

1 fundo

Medidas: 19x19x14

parede estrutural de 3cm

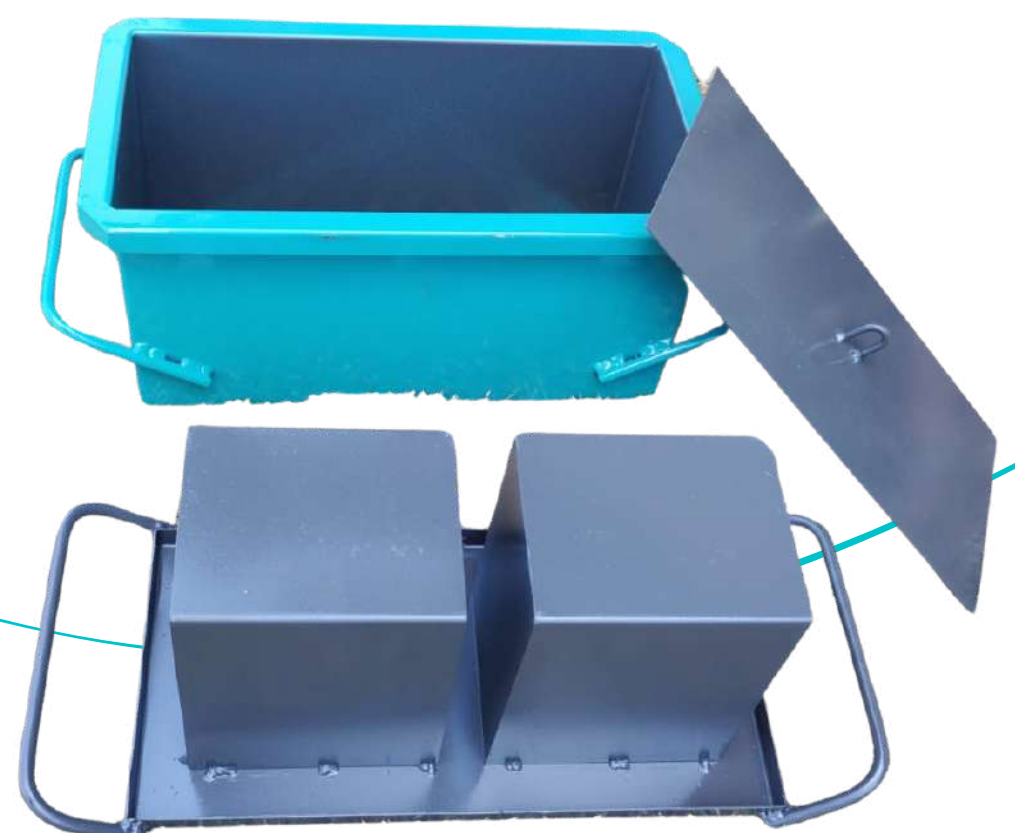

# KIT FORMA METÁLICA

## Kit Bloco Estrutural Meio Bloco Sem Fundo

Ref: NF 216

1 tampa para desenformar

1 caixa

1 fundo

Medidas: 19x19x14

parede estrutural de 3cm



## Kit Bloco Vedação Vazado

Ref: NF 221

1 tampa para desenformar

1 caixa

1 fundo

Medidas: 19x19x39

parede estrutural de 3cm



# Formas Metálicas

## Moerão Reto



2,5 metros NF 86

3 metros NF 126

## Moerão Industrial

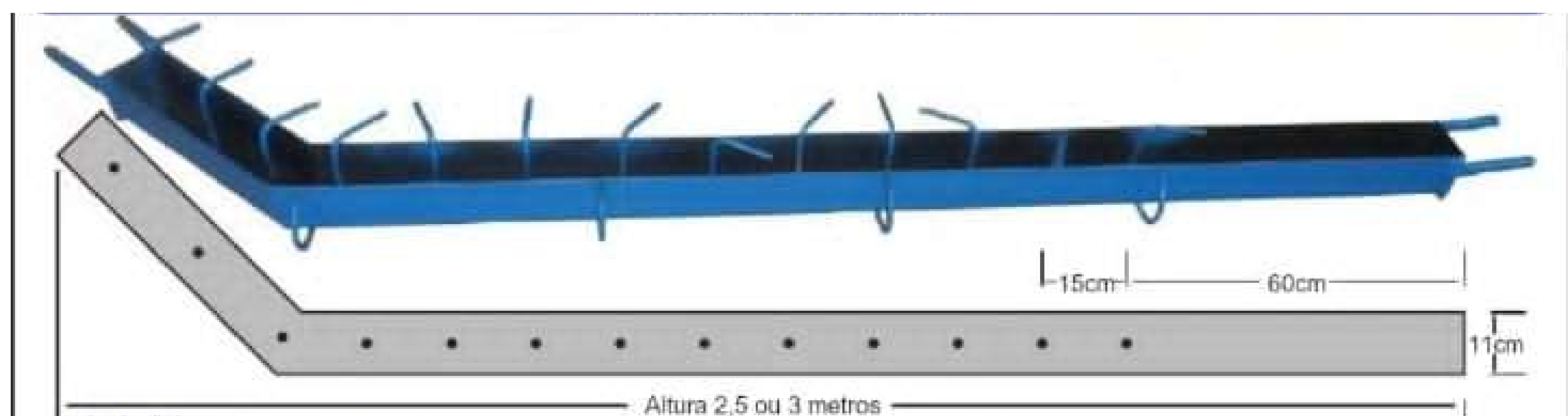

2,5 metros NF 127

3 metros NF 128

## Poste Varal



2,5 metros NF 130

3 metros NF 129



# Formas Metálicas

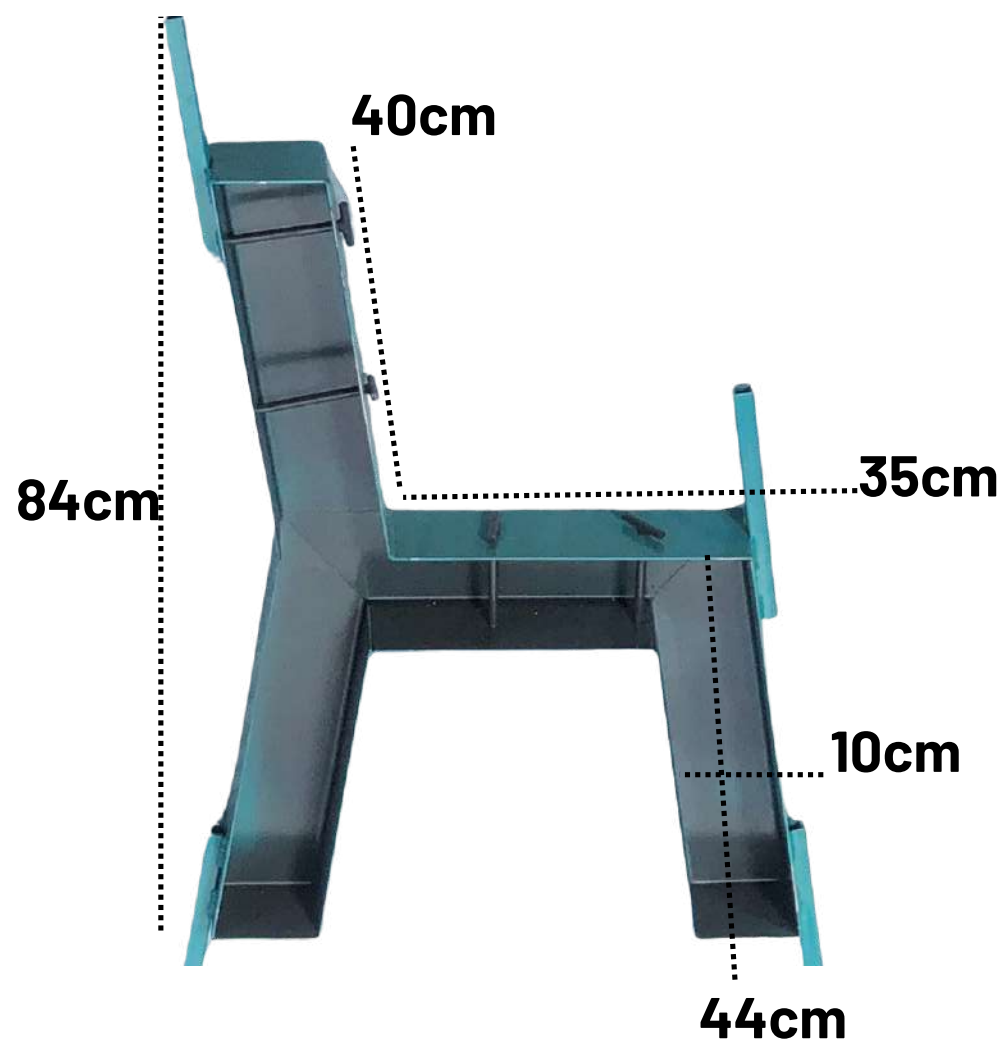

## Pé de banco

Individual

Conjunto

Ref: 186

Ref: NF 189

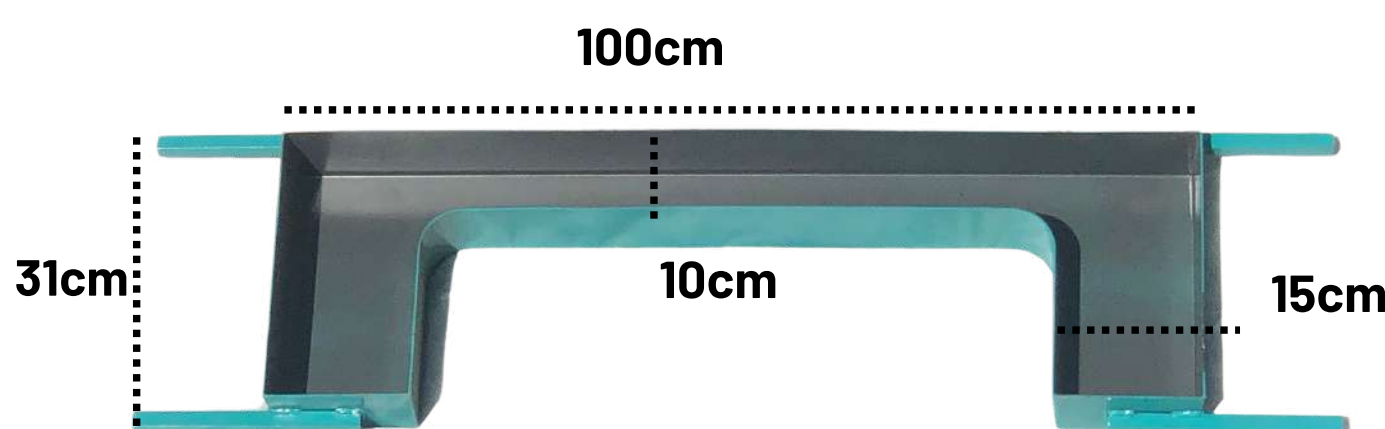

## Guia Suporte Boca de Lobo

Ref: NF 186

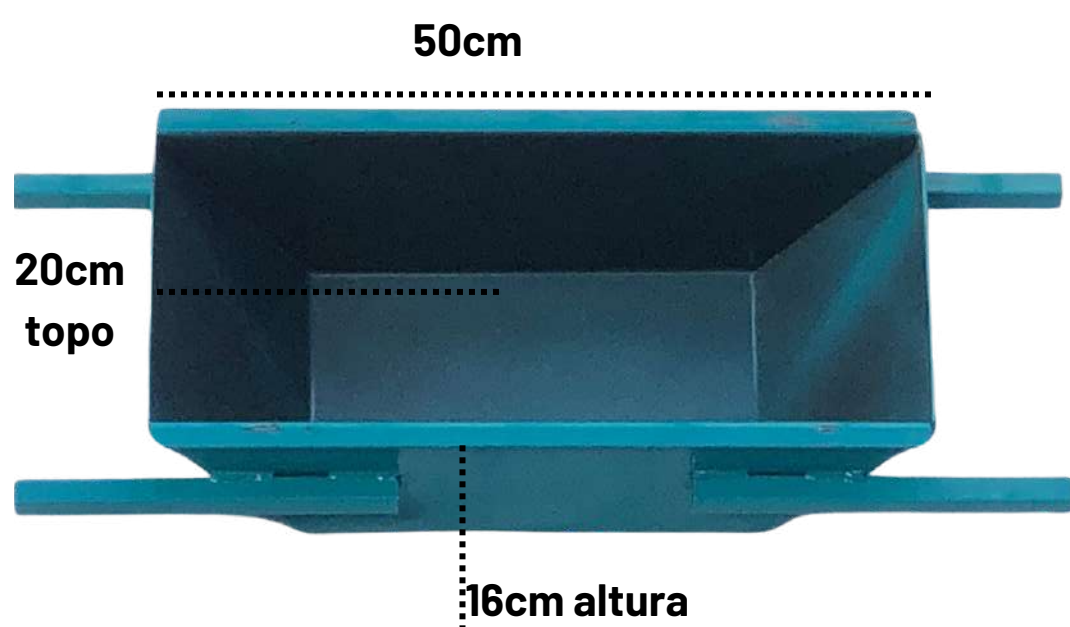

## Bate Roda

Ref: NF 194

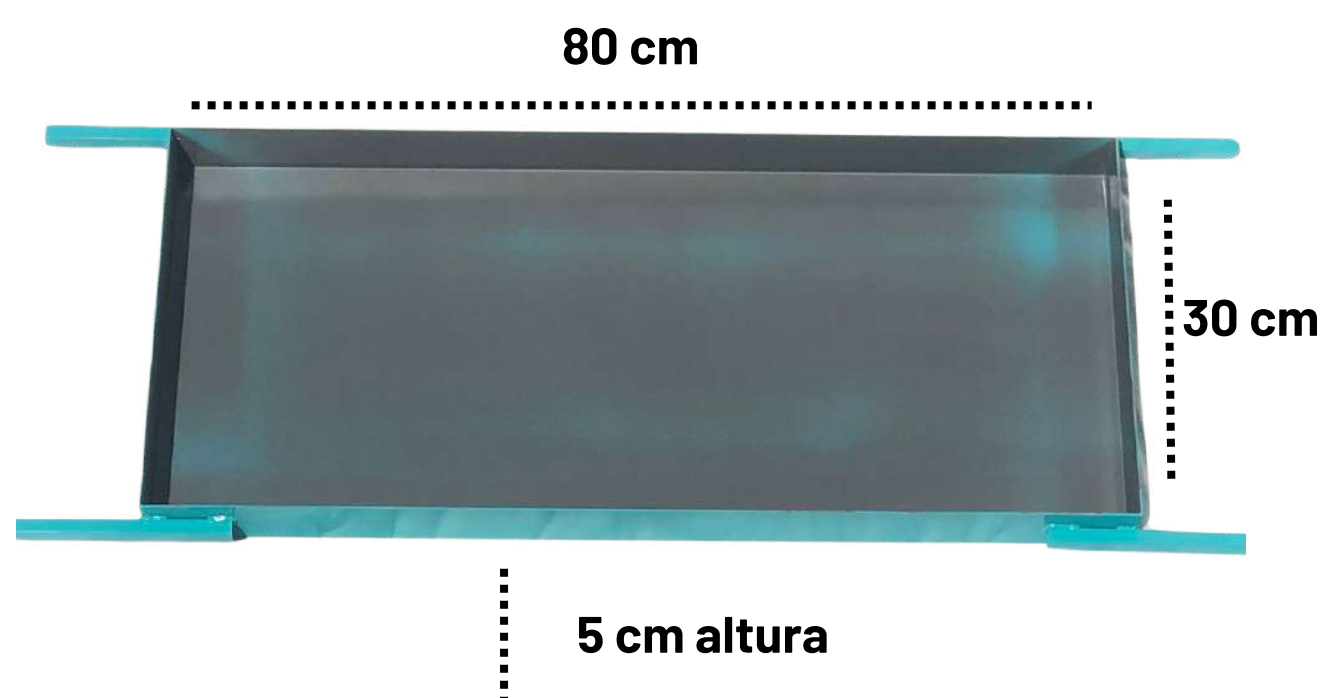

## Degrau/Drenante/Jardim

Ref: NF 202

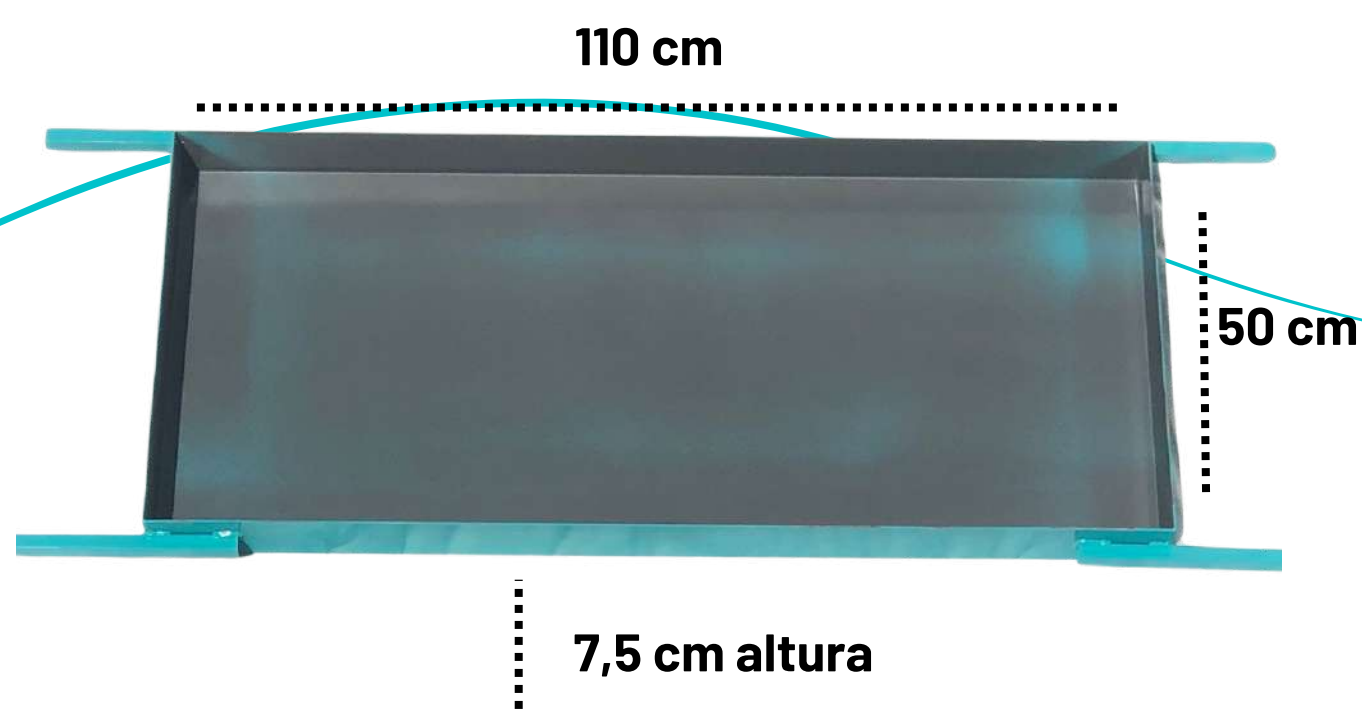

## Tampa Boca de Lobo

Ref: NF 199

# DESMOLDANTE

**5 LITROS**

NF 100

**200 LITROS**

NF 100/2



O desmoldante deve ser dissolvido em água, 1 litro de desmoldante em até 4 litros de água, este produto deve ser bem misturado e sempre que for utilizar agitar o produto, a aplicação deve ser feita com borrifador ou pistola de ar.

OBS \*Misturar sempre o que for utilizar ao longo do dia

# ADITIVO PLASTIFICANTE

NF 103



**Dosagem:** Substitua o uso de 20kg de cal hidratado por 1 saco se 50g desse aditivo.

**Modo de preparo:** A mistura é igual a da cal hidratada, deve ser adicionado junto com os componentes secos (cimento, agregados e etc.) e misturar antes da adição de água.

**Aplicação:** Argamassa para rebocos internos/externos, revestimento, pisos e contra pisos, vedação e de assentamento em geral.

**Composição Qualitativa:** Aditivos minerais e em pó.

**Armazenagem:** Manter em local coberto, fresco e seco nas embalagens originais e lacradas. Longe do alcance de crianças.

**Toxicidade:** Produto não considerado tóxico, porém impróprio para o consumo humano. Evitar contato com a pele e os olhos.

**Prazo de validade:** 24 meses

#### Traços recomendados

- 1 saco de cimento
- 1 pacote de aditivo
- 7 latas de 18 litros de areia média/ média fina

**Rendimento:** 123 litros

# ADITIVO PLASTIFICANTE

PERMITE REDUÇÃO DA  
ÁGUA DE  
AMASSAMENTO PARA  
UMA MESMA  
CONSISTÊNCIA

FACILITA O ADENSAMENTO  
E O LANÇAMENTO DO  
CONCRETO

AUMENTA A FLUIDEZ  
POR TEMPO  
PROLONGADO

MELHORA A COESÃO DO  
CONCRETO, REDUZINDO A  
SEGREGAÇÃO;



REDUZ A  
PERMEABILIDADE;  
REDUZ RETRAÇÕES  
DIMINUINDO A  
TENDÊNCIA AO  
APARECIMENTO DE  
FISSURAS.

PROPORCIONA ALTAS  
RESISTÊNCIAS  
MECÂNICAS INICIAIS E  
FINAIS;

**5 LITROS**  
NF 1001

**220 LITROS**  
NF 1002

# PIGMENTOS



**PIGMENTO NIAR B 318**

**Ref: Nf 119 - 10Kg**

**Ref: Nf 115 - 25kg**



**IOX NIAR Y 02**

**Ref: Nf 119 - 10kg**

**Ref: Nf 116 - 20kg**



**IOX NIAR R 02**

**Ref: Nf 118 - 10kg**

**Ref: Nf 117 - 25kg**



**IOX NIAR M 975**

**Ref: Nf 122 - 20kg**

**QUALITY WORKS.**

**LANXESS**  
Energizing Chemistry



**NF 19**  
 Molde 4 PEÇAS 20X10X6  
 50 pçs p/ m<sup>2</sup>



**NF 111**  
 Molde 2 PEÇAS 20X10X4  
 50 pçs p/ m<sup>2</sup>



**NF 18**  
 Molde 2 PEÇAS 20X10X6  
 50 pçs p/ m<sup>2</sup>



**NF 17**  
 Molde 2 PEÇAS 20X10X8  
 50 pçs p/ m<sup>2</sup>



**NF 22**  
 Molde 4 PEÇAS 24X10X6  
 42 pçs p/ m<sup>2</sup>

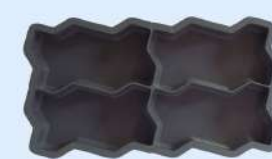

**NF 20**  
 Molde 2 PEÇAS 24X10X6  
 42 pçs p/ m<sup>2</sup>



**NF 21**  
 Molde 2 PEÇAS 24X10X8  
 42 pçs p/ m<sup>2</sup>



**NF 26**  
 Molde 4 PEÇAS 25X15X6  
 32 pçs p/ m<sup>2</sup>



**NF 16**  
 Molde 1 PEÇA 25X15X6  
 32 pçs p/ m<sup>2</sup>



**NF 15**  
 Molde 1 PEÇA 25X15X8  
 32 pçs p/ m<sup>2</sup>



# FÔRMA PLÁSTICA PARA GRAMA



**45X35X7CM**

NF 78

7 formas faz 1m<sup>2</sup>



**30X30X5CM**

NF 76

12,5 pçs p/ m<sup>2</sup>

# FÔRMA BOLACHÃO CAMINHO DE JARDIM

**45X40X4CM**

NF 55



**60X50X4CM**

NF 56





# MODELO MADEIRA

## MODELO 1 80X20X3CM

NF 59



## MODELO 2 1X14CMX3CM

NF 58



# MODELO MADEIRA

## MODELO 3 1,2MX13CMX3CM

NF 57



## MODELO 4 1MX28CMX3CM

NF 60



# DORMENTE

**1,2MX30CMX4CM**

NF 61

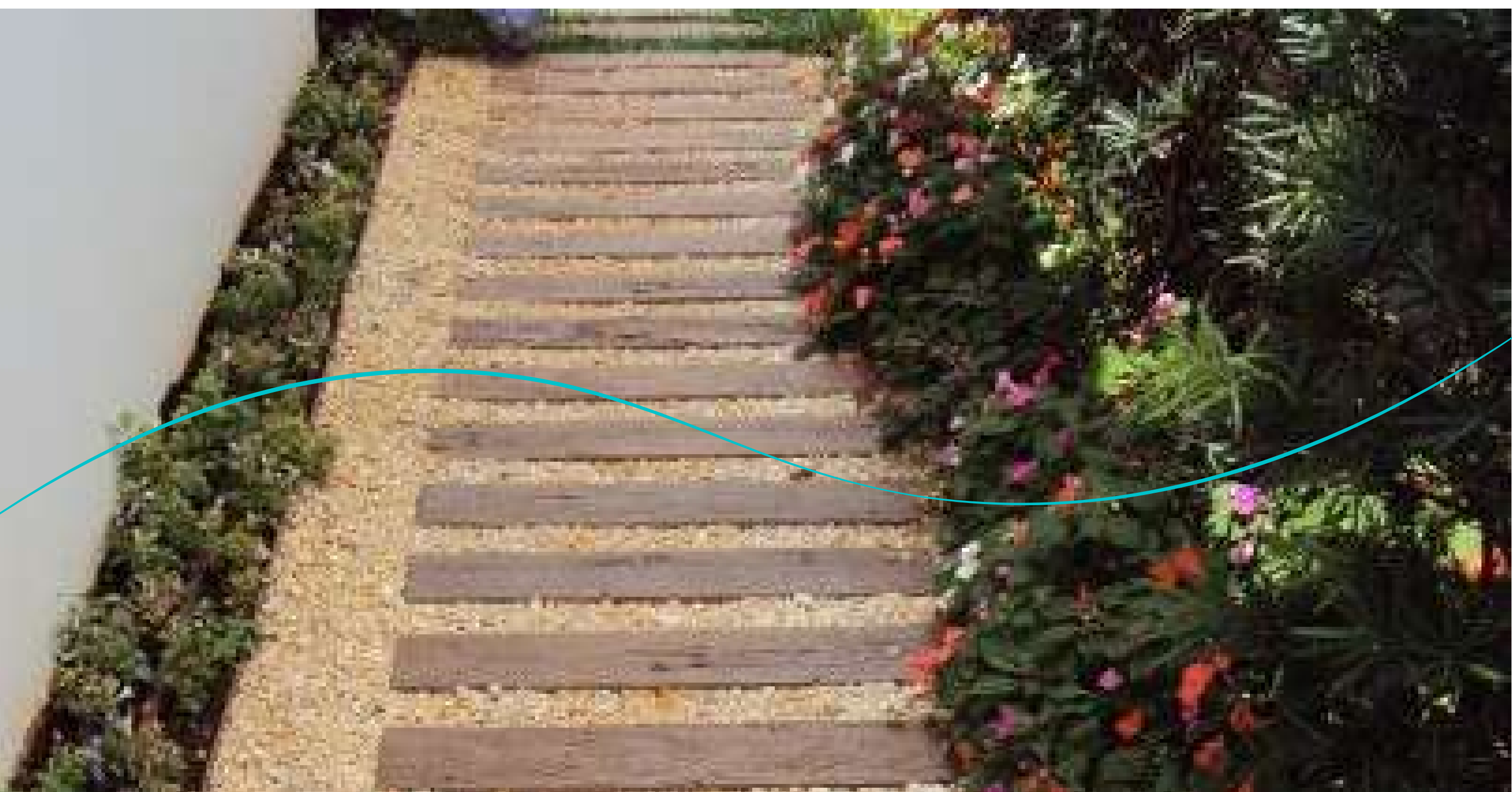

# FORMA PLÁSTICA PALITO

## Revestimiento Palito

49x49x2,5

NF 73



## Pedra Palito

70x30x3cm

NF 64



# FORMA PLÁSTICA SEXTAVADA LOSÂNGO

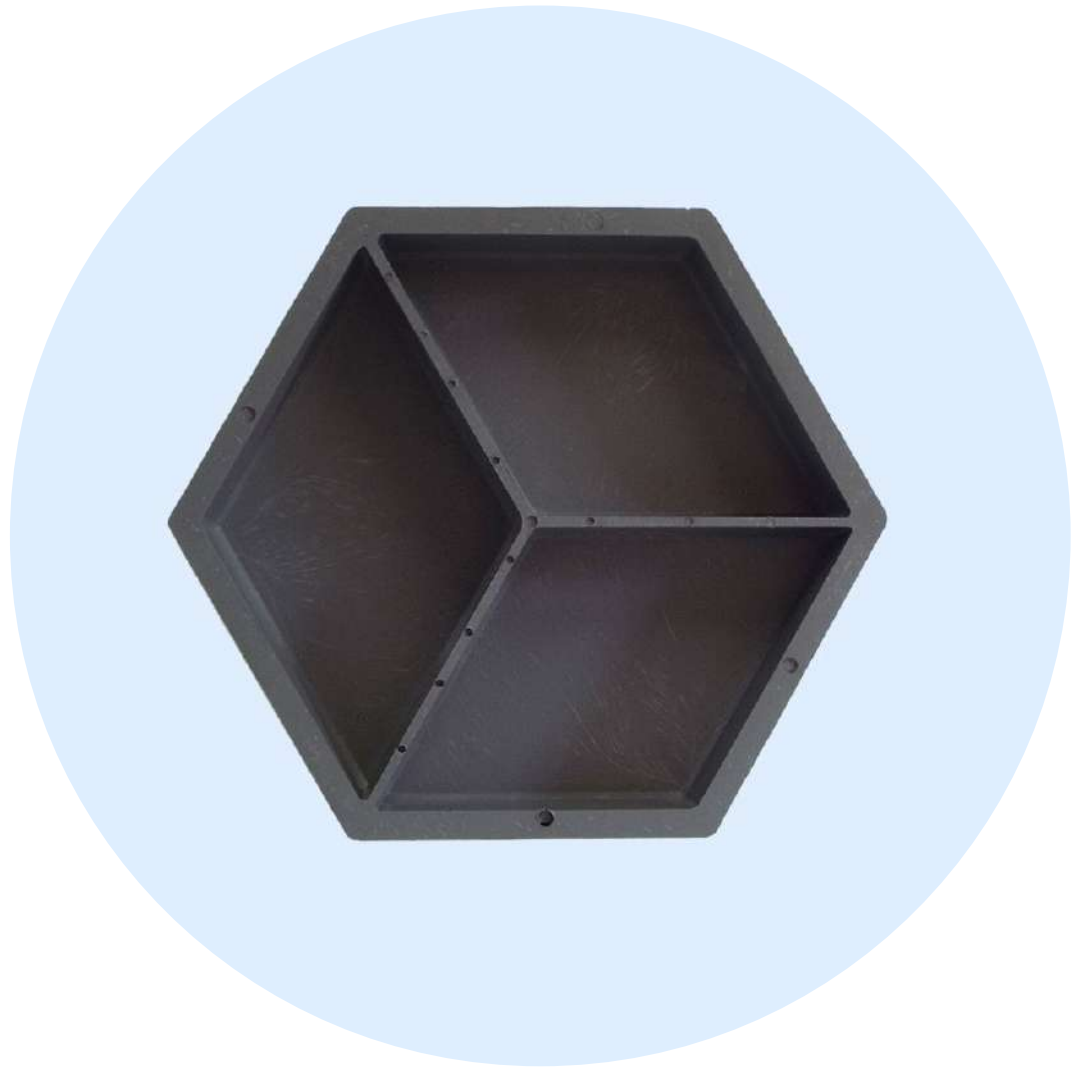

**30x30x6CM**

NF 63

34,5 pçs por m<sup>2</sup>

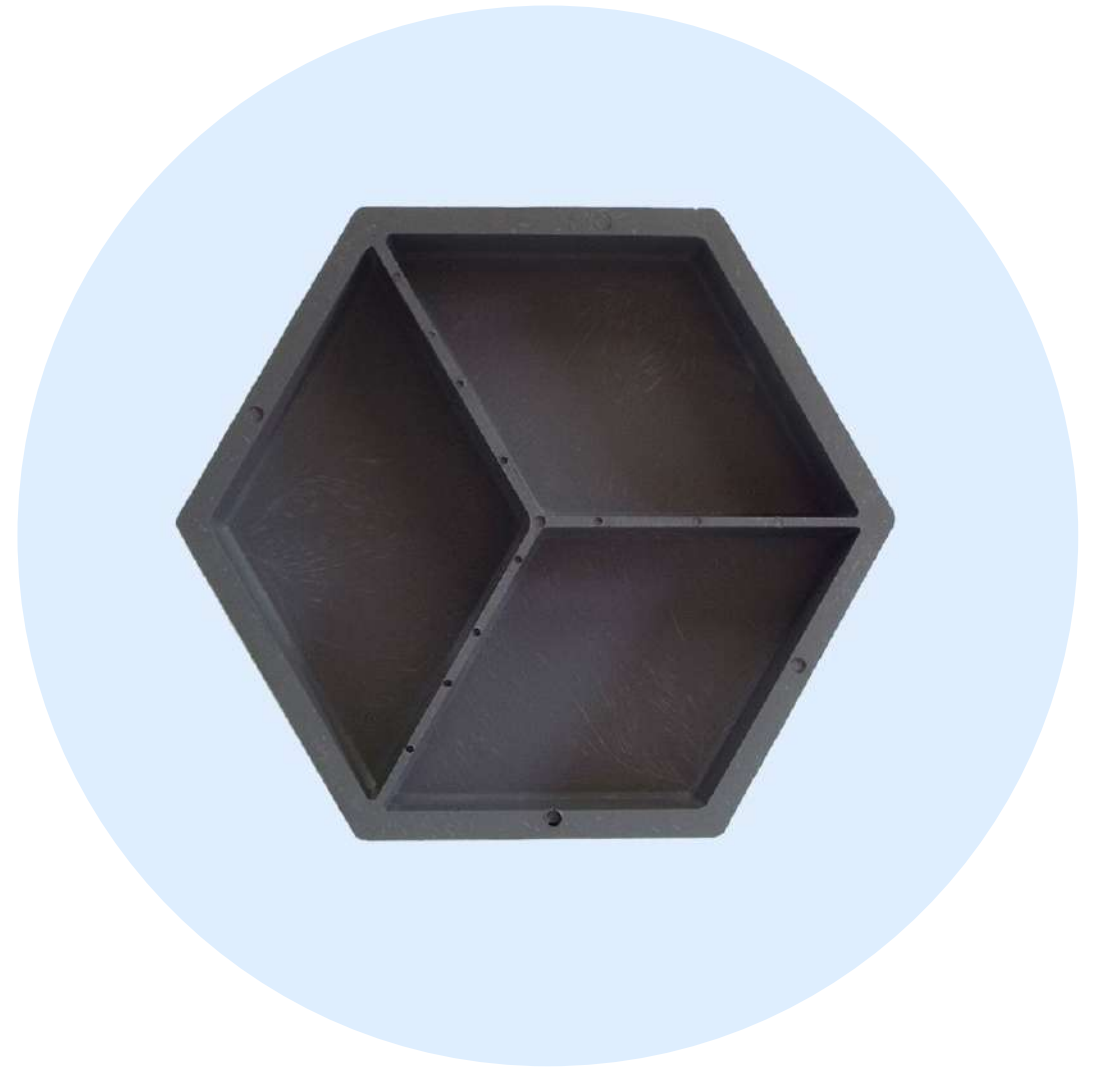

**30X30X8CM**

NF 62

34,5 pçs por m<sup>2</sup>

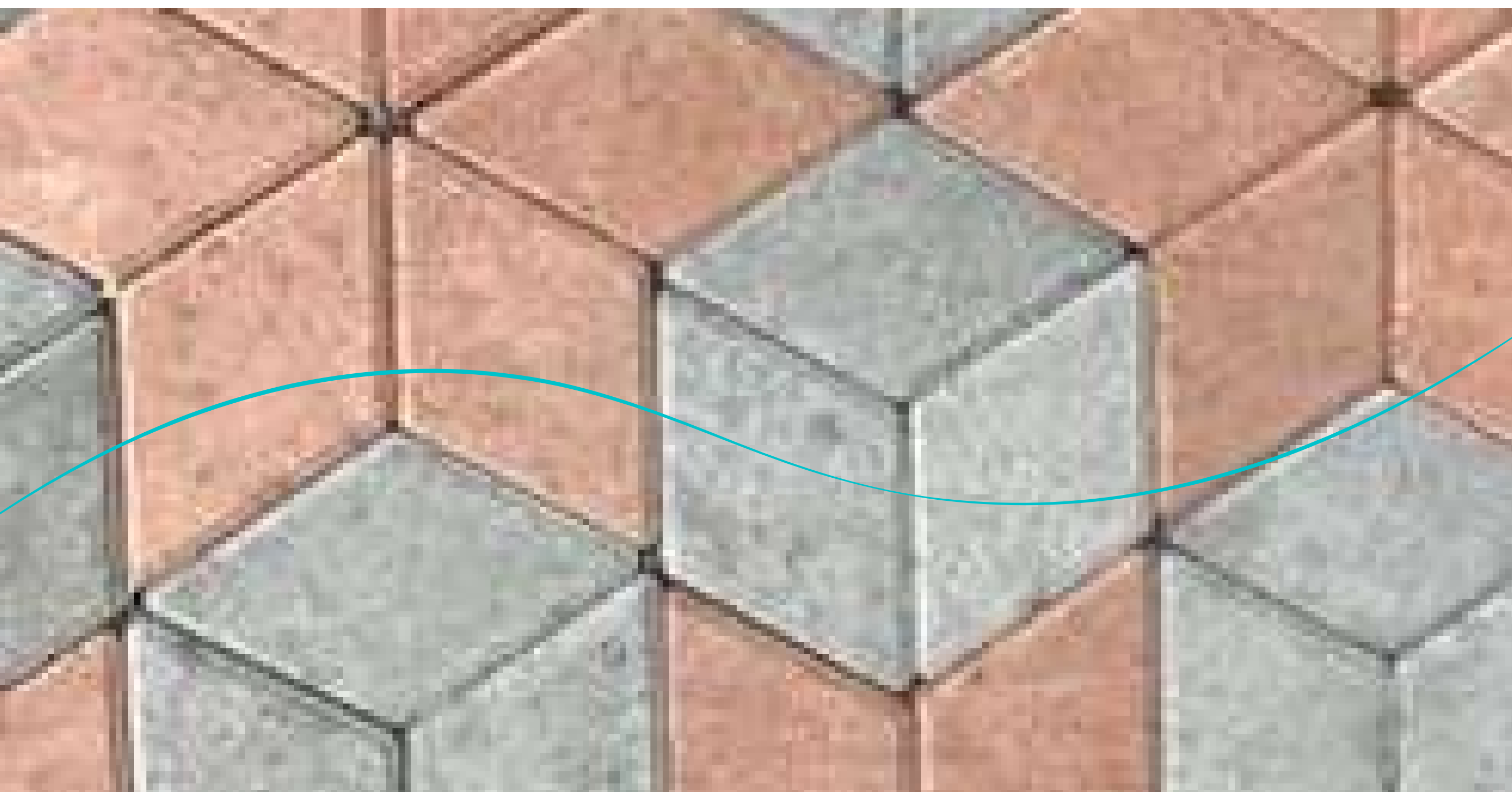

# SEXTAVADA LISA



**25x25x6**  
NF 10  
17 pçs por m<sup>2</sup>



**25x25x8**  
NF 09  
17 pçs por m<sup>2</sup>



**30x30x6**  
NF 12  
12,5 pçs p/ m<sup>2</sup>



**30x30x8**  
NF 11  
12,5 pçs p/ m<sup>2</sup>



**30x30x10**  
NF 13  
12,5 pçs por m<sup>2</sup>



# SEXTAVADA ESTRIADA



**25x25x6**  
NF 32  
17 pçs por m<sup>2</sup>



**25x25x8**  
NF 38  
17 pçs por m<sup>2</sup>



**30x30x6**  
NF 014  
12,5 pçs p/ m<sup>2</sup>



**30x30x8**  
NF 37  
12,5 pçs p/ m<sup>2</sup>



# SEXTAVADA EXTRA GRANDE



**25x25x6**

NF 34

17 pçs por m<sup>2</sup>



**25x25x8**

NF 33

17 pçs por m<sup>2</sup>



**30x30x6**

NF 35

12,5 pçs p/ m<sup>2</sup>



**30x30x8**

NF 36

12,5 pçs p/ m<sup>2</sup>

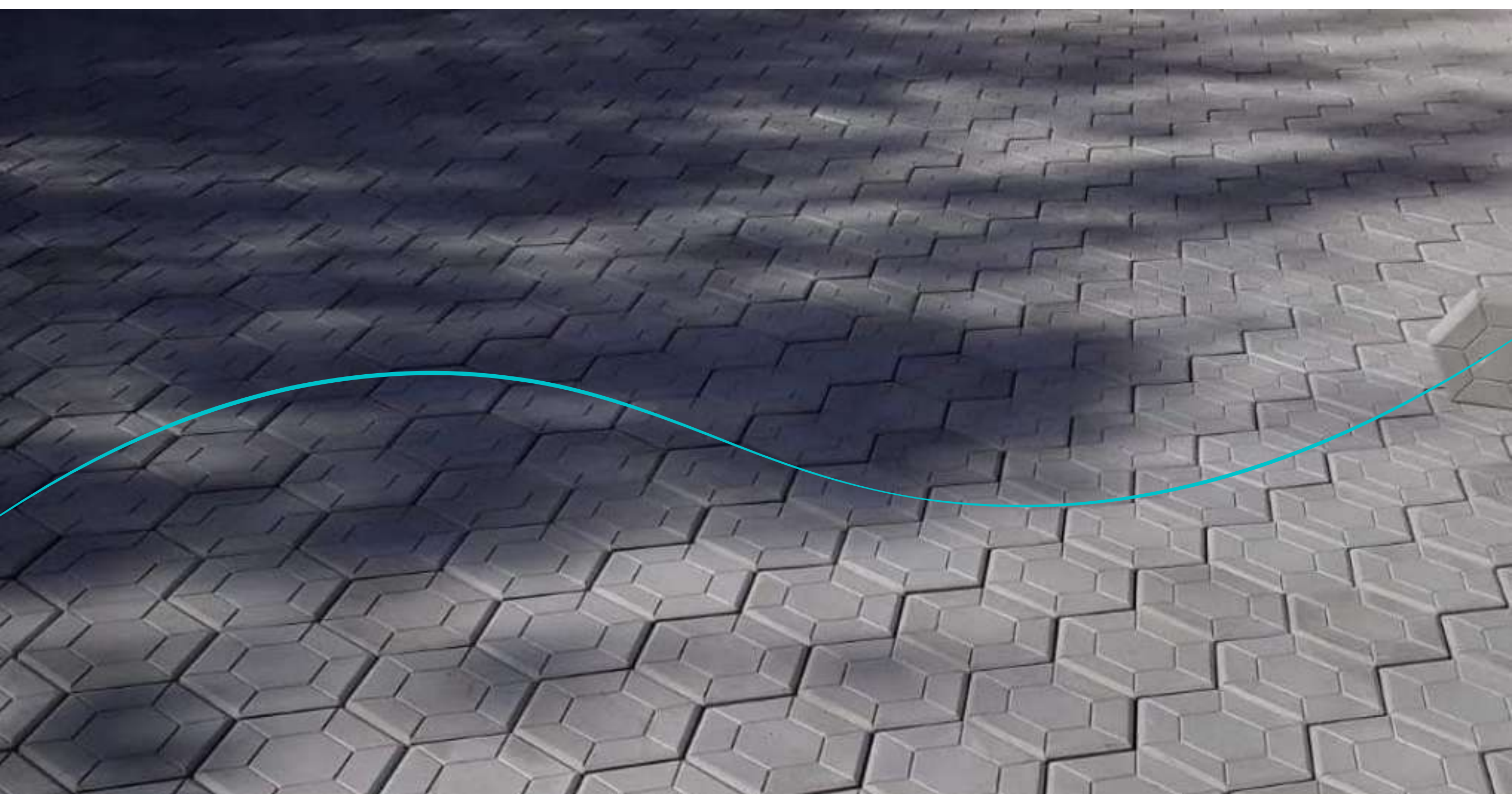



# PISO TÁTIL / BROTOEJA DEFICIENTE VISUAL



**20X20X6**

NF 23

25 pçs por m<sup>2</sup>

4 GUIAS



**25x25x2,5**

NF 06

16 pçs por m<sup>2</sup>

5 GUIAS



**25X25X6**

NF 30

16 pçs por m<sup>2</sup>

5 GUIAS



**30X30X2,5**

NF 07

11,5 pçs p/ m<sup>2</sup>

6 GUIAS

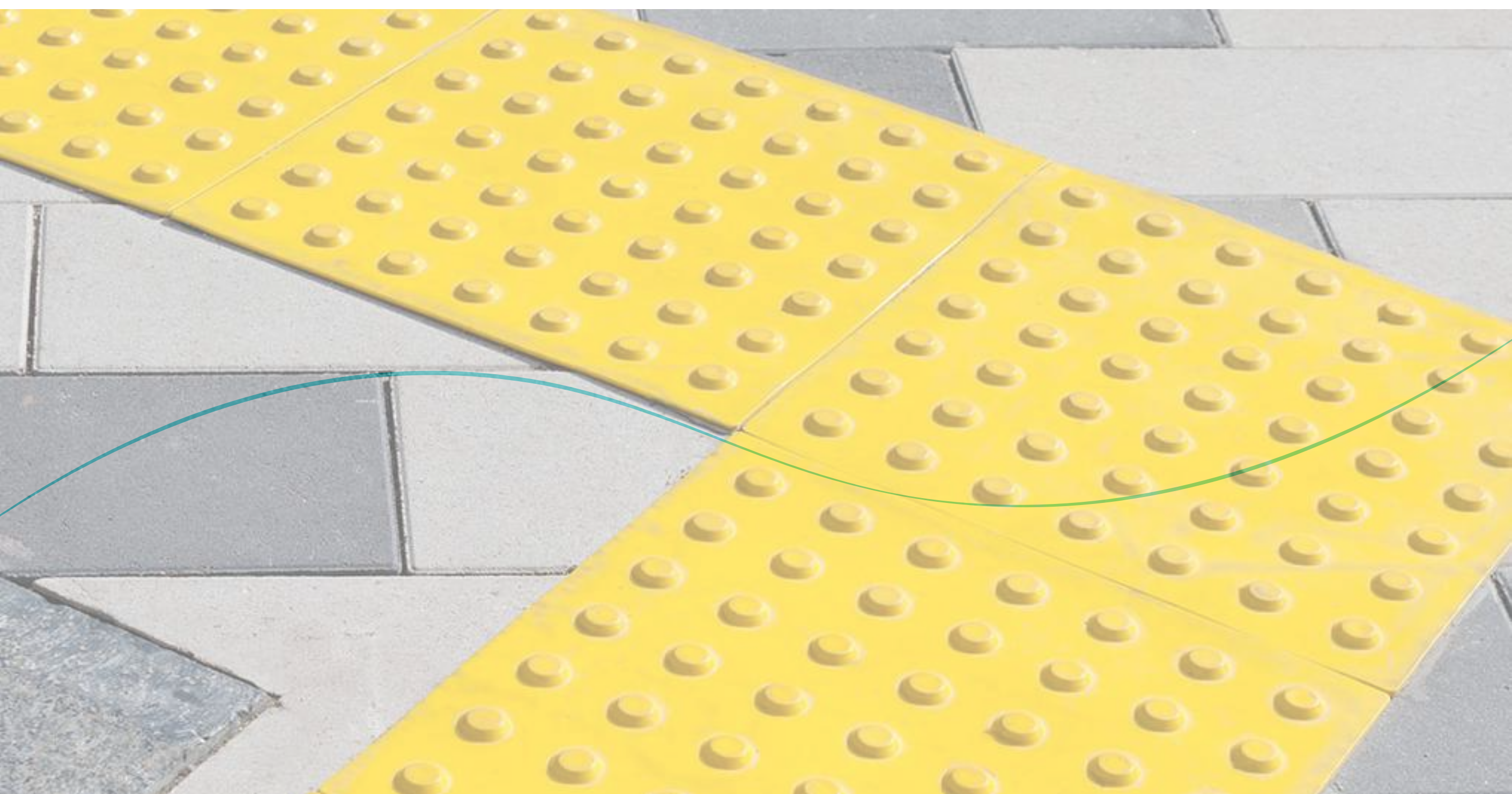

# PISO TÁTIL / RETA DEFICIENTE VISUAL



**20X20X6**

NF 24

25 pçs por m<sup>2</sup>

3 FRISOS



**25x25x2,5**

NF 25

16 pçs por m<sup>2</sup>

3 FRISOS



**25X25X6**

NF 28

16 pçs por m<sup>2</sup>

3 FRISOS



**30X30X2,5**

NF 29

11,5 pçs p/ m<sup>2</sup>

4 FRISOS

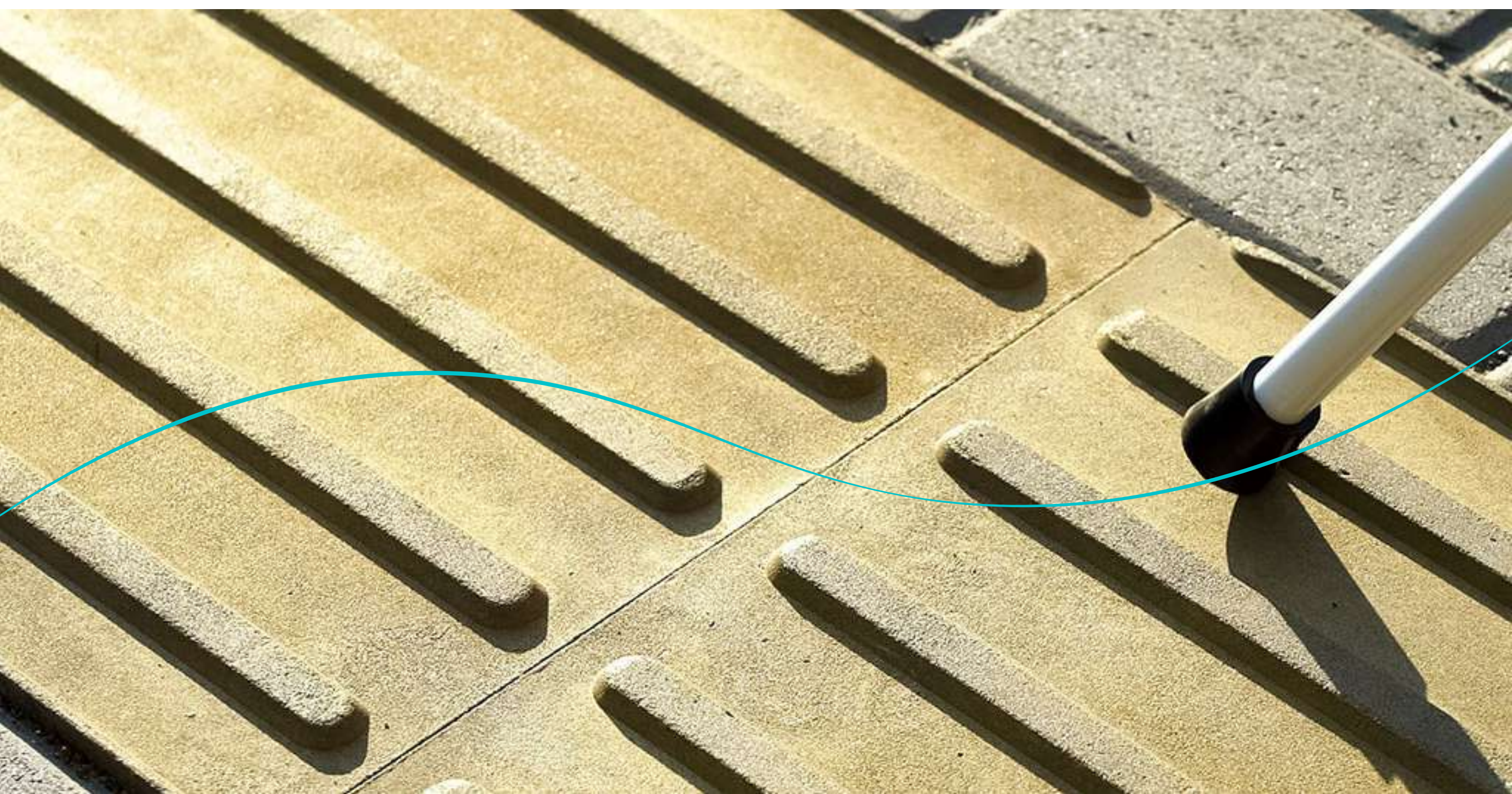

# FORMA 49X49X2,5



25 pçs por m<sup>2</sup>

**Ladrilho 25 quadros**  
**Ref: NF 44**  
20x20x1,5cm



12 pçs por m<sup>2</sup>

**Frisada**  
**Ref: NF 77**  
30x30x2,5cm



25 pçs por m<sup>2</sup>

**Antiderrapante 10 Frisos**  
**Ref: NF 05**  
20x20x2cm



**Adaptador de Borda**  
**Ref: NF 81**

# FORMA 49X49X2,5



**Floco de Neve**  
**Ref: NF 39**  
49x49x2,5cm



**Copacabana**  
**Ref: NF 01**  
49x49x2,5cm



**Estriada**  
**Ref: NF 03**  
49X49X2,5cm



**Quadrada Lisa**  
**Ref: NF 31**  
49X49X2,5cm



**Monta Quadrada**  
**Ref: NF 04**  
49X49X2,5



**Monta Quadrada Rústica**  
**Ref: NF 74**  
49X49X2,5

# FORMA 49X49X2,5



4 pçs por m<sup>2</sup>

**Xadrez**  
**Ref: NF 02**  
49x49x2,5cm



4 pçs por m<sup>2</sup>

**Granito**  
**Ref: NF 83**  
49x49x2,5cm



4 pçs por m<sup>2</sup>

**Quadrada Pirâmide**  
**Ref: NF 179**  
49X49X2,5cm

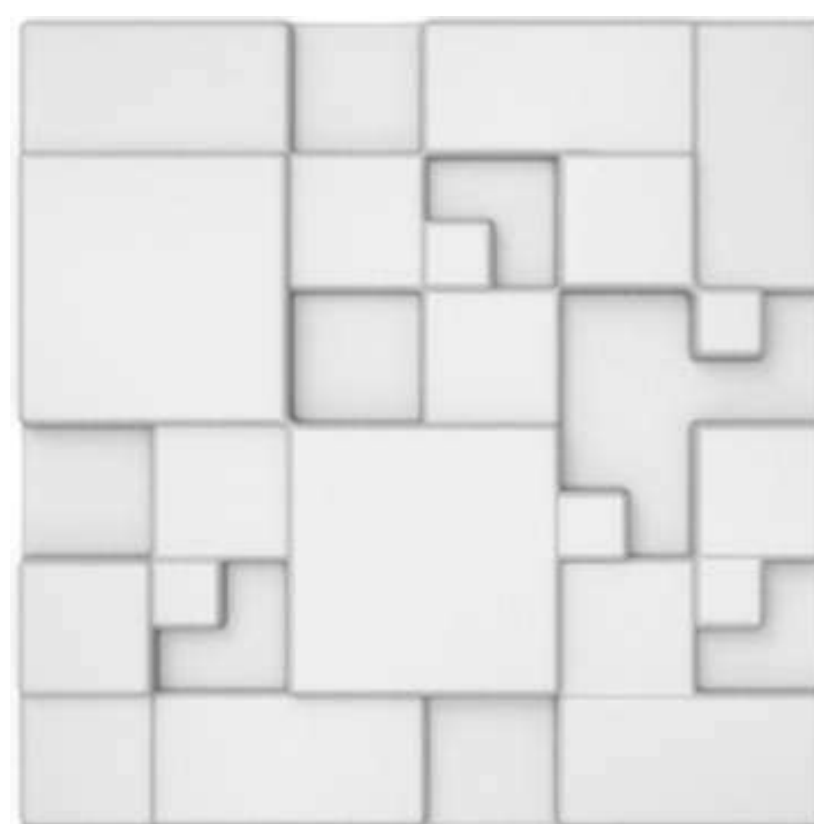

**Ref: A0002**  
29X29X2CM

# ANTIDERRAPANTE PISCINA



4 pçs por m<sup>2</sup>

**Ref:Bo0201**  
49x49x31x3cm



4 pçs por m<sup>2</sup>

**Ref: NF 40**  
49X49X2,5cm



**Ref:B00200**  
59X32X3cm



**Ref: NF 42**  
49X32X2,5cm

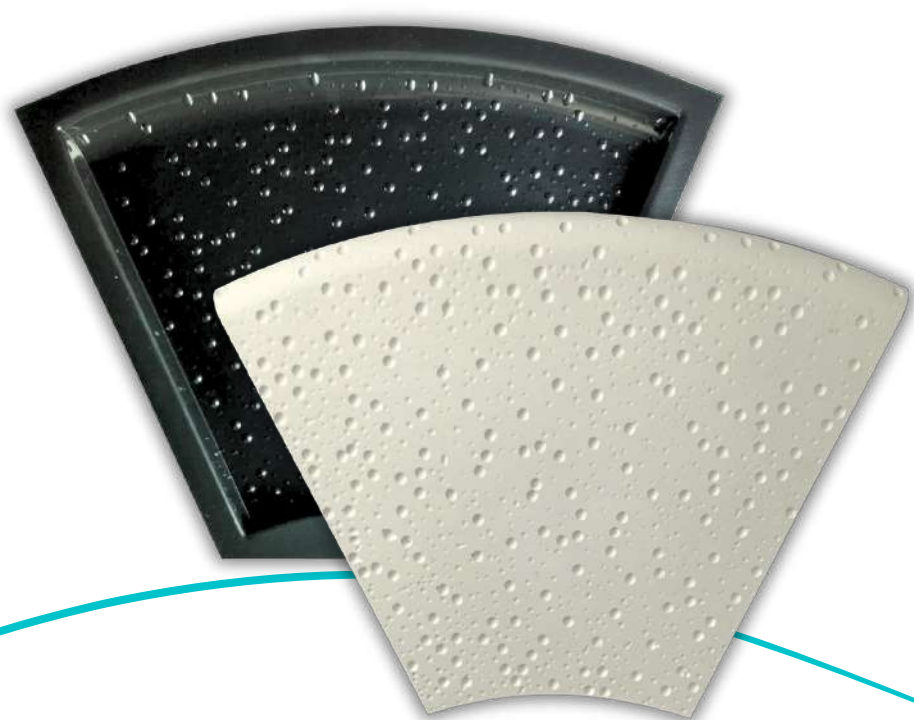

**Ref:B00203**  
43x33x2,7

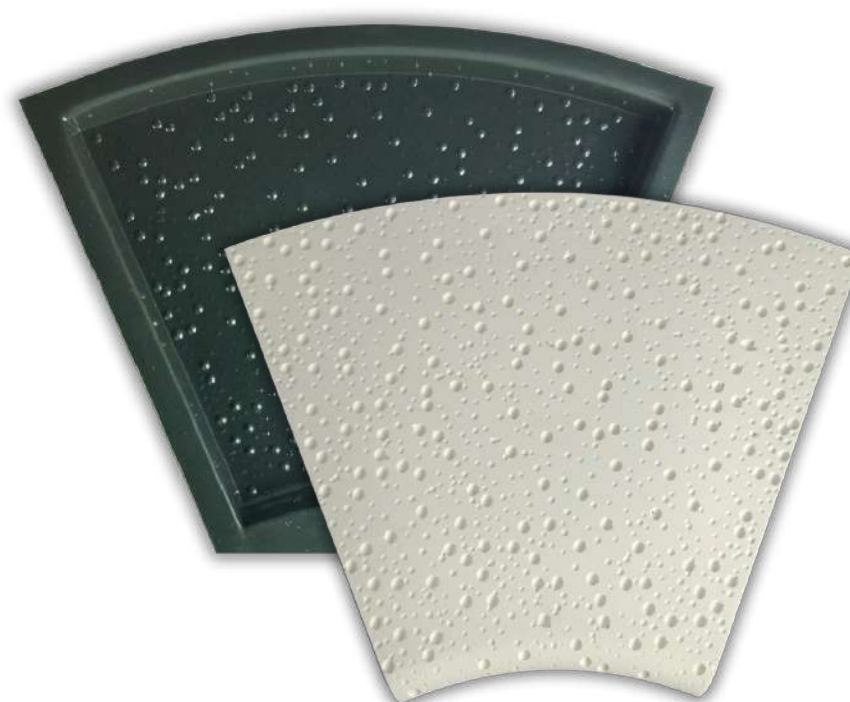

**Ref:B00204**  
43x33x2,7

# ANTIDERRAPANTE PISCINA

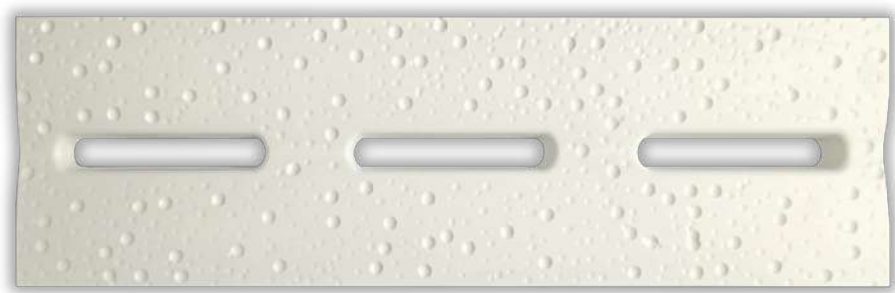

**Ref:Bo0205**  
15x49x2,7cm



**Ref:Bo0207**  
30x49x2,7cm



**Ref:Bo0206**  
20x49x2,7cm

# MEIO FIO



**Ref:NF 27**  
80X30X12 base x 10 topo



**Ref: NF 47**  
80X20X4CM

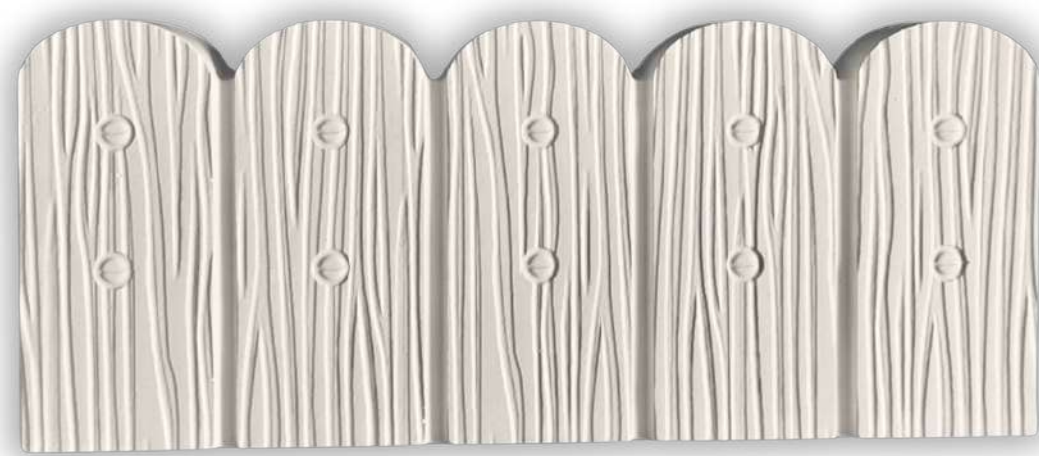

**Ref:CE0805**  
21x50x4cm

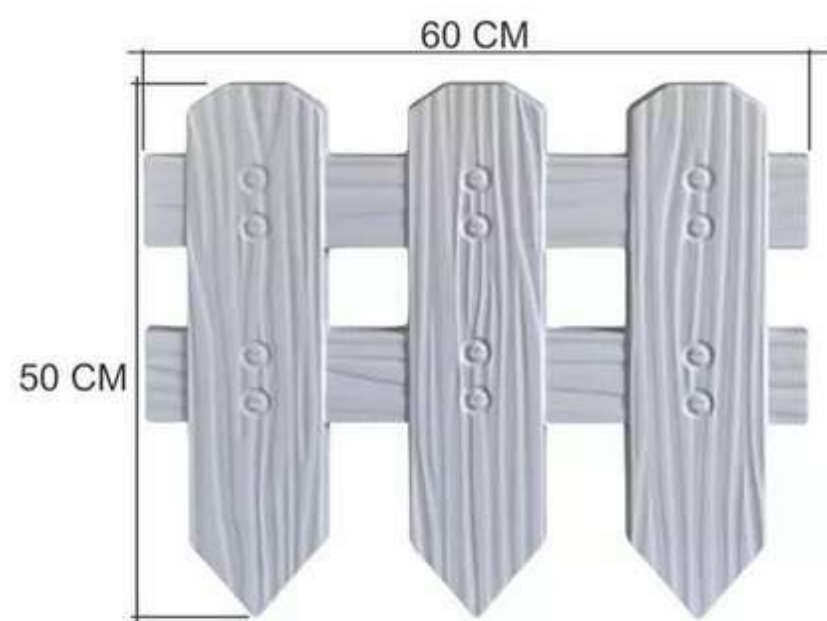

**Ref:0804**  
20x60X4cm



**Ref:CE0806**  
21x50x4cm



# FORMA PLÁSTICA INJETADA



MODELO A0504

MEDIDA 30 X 30 X 3 CM

ESPESSURA PRONTO 6,5 CM NO COBOGÓ PRONTA.

Duas peças p/ fazer um cobogó

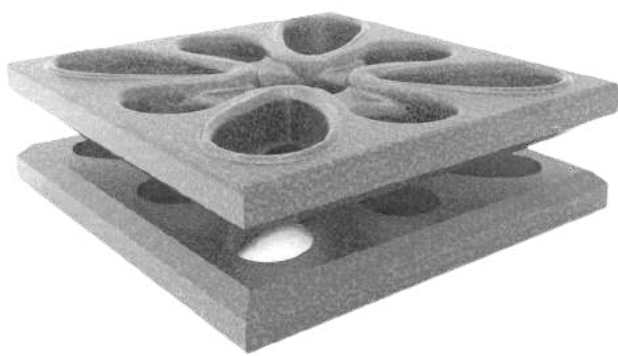

Pode colocar uma placa sobre outra para colagem

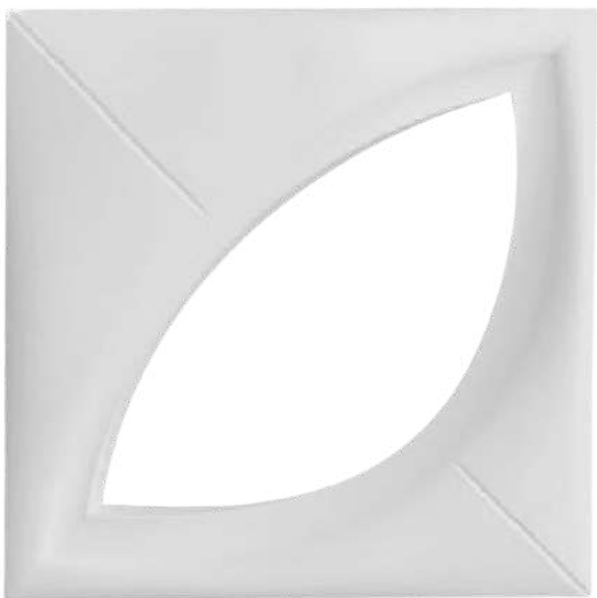

MODELO C005000

MEDIDA 30 X 30 CM

ESPESSURA PRONTO 8 CM

Duas peças p/ fazer um cobogó

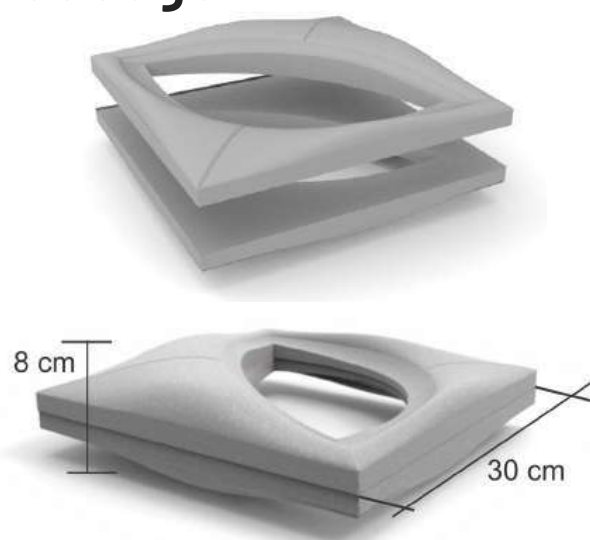

Pode colocar uma placa sobre outra para colagem



# FORMA PLÁSTICA INJETADA

MODELO A0300

MEDIDA 18 X 15 CM

4 MODELOS HEXAGONAL 1

MODELO ROMBO

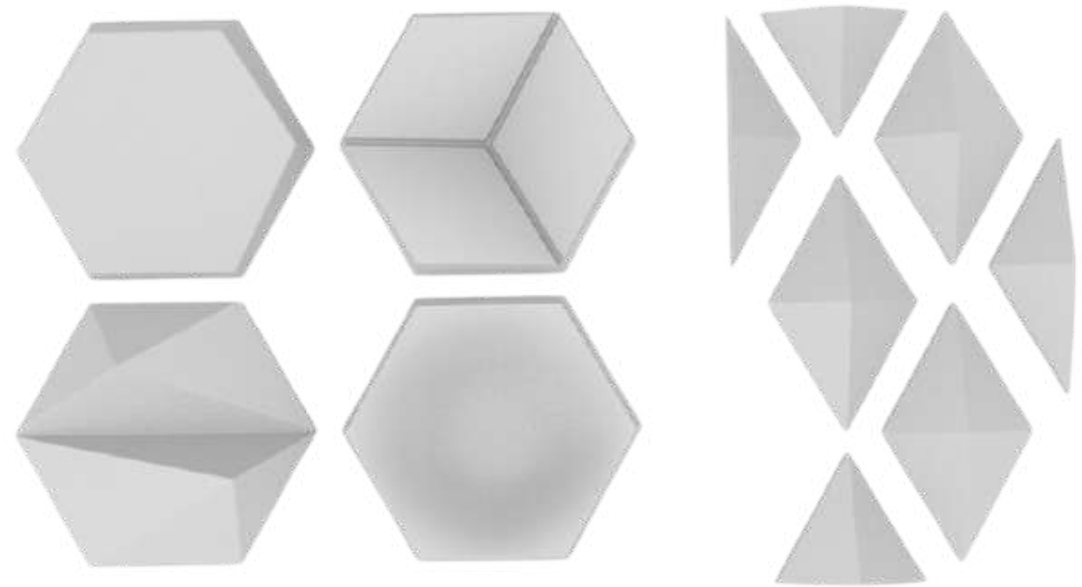

Duas peças p/ fazer um cobogó



Pode colocar uma placa sobre outra para colagem

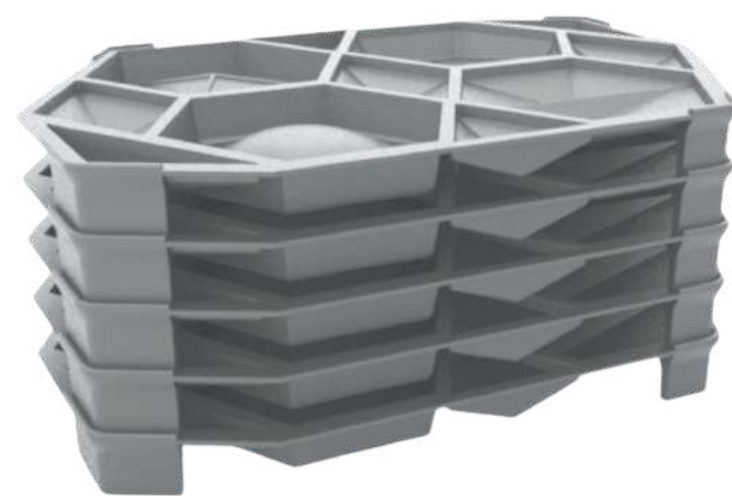

MODELO A0505

MEDIDA 30 X 30 X 3 CM

ESPESSURA PRONTO 6,5 CM NO COBOGÓ

PRONTA



Duas peças p/ fazer um cobogó

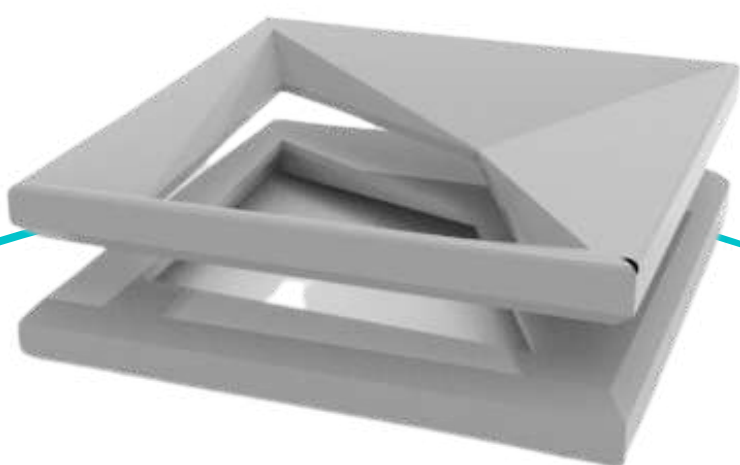

Pode colocar uma placa sobre outra para colagem



# ESPAÇADOR PARA FERRAGEM

**8cmx6cmx0,8mm**

NF 41

o milho

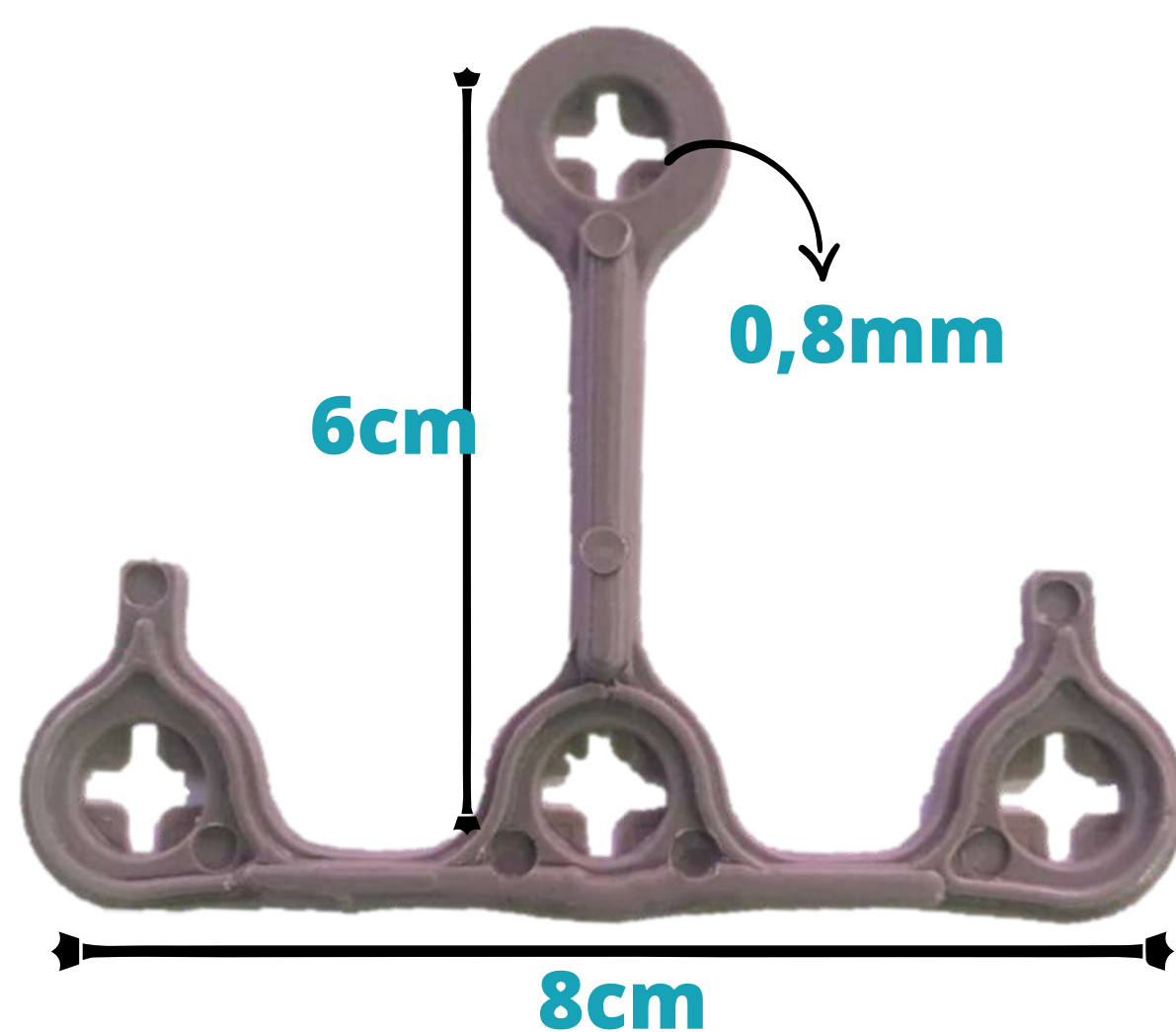

**8cmx6cmx1,5mm**

NF 67

o milho

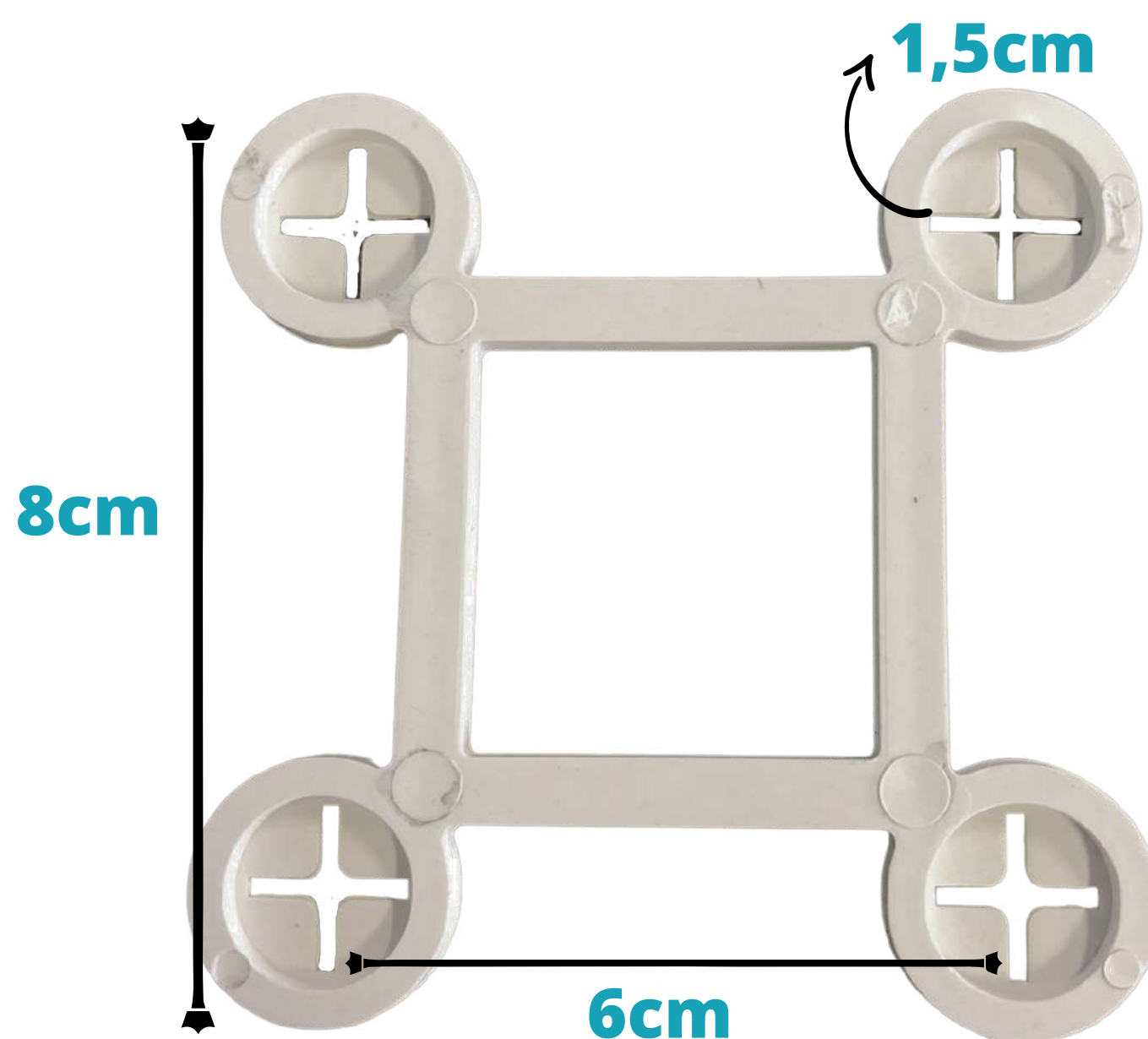

# COBOGÓ OU ELEMENTO VAZADO



**0509 - 40x40cm**



**0512 - 40x40cm**

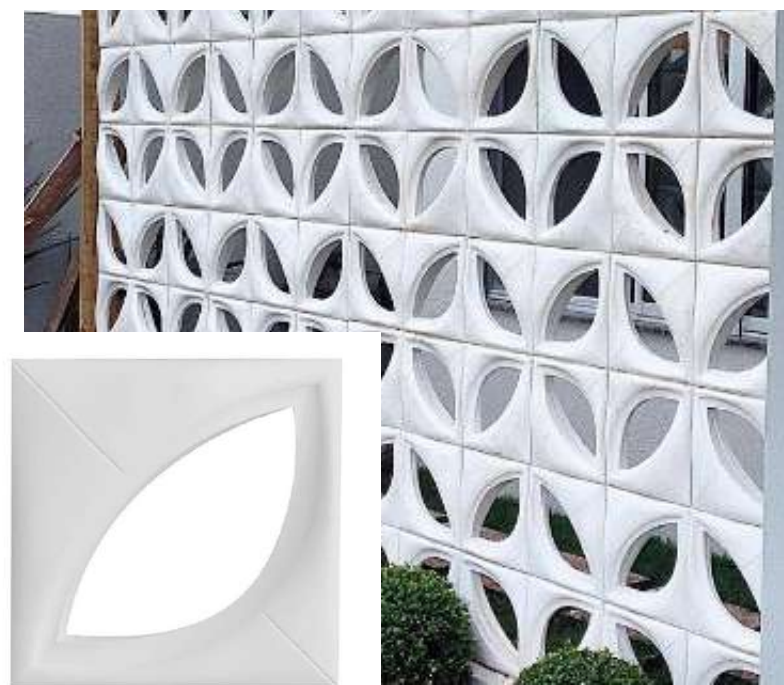

**S00500 - 30x30cm**



**0513 - 40x40cm**



**0514 - 40x40cm**



**00501 - 30x30cm**



**0510 - 40x40cm**



**0511 - 40x40cm**



**0507 - 30x30cm**

# FÔRMA VACUUM FORMING



**PÉ ESQUERDO**

Ref: PI0014

**PÉ DIREITO**

Ref: PI0015



**Ref:I0016**

49x49cm



**Ref:PI0018 19 x 58,5 x 4,5**  
de espessura no topo 2cm  
na borda



**Ref:0243**

60x30cm

# FORMA VACUUM FORM



**Ref:0274**  
50x50cm

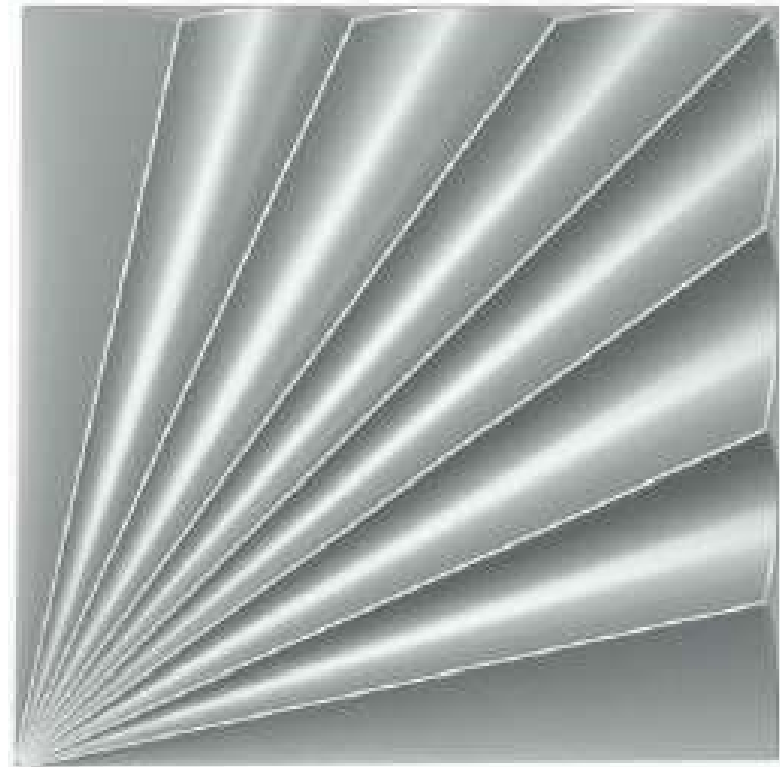

**Ref:0140**  
50x50cm



**Ref:001200**  
34x34cm

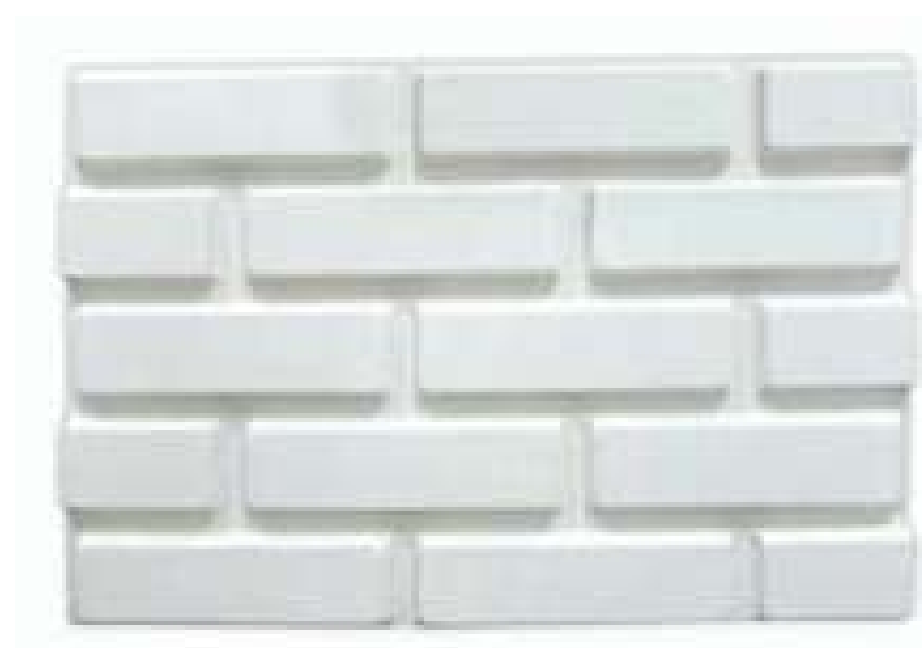

**Ref:0186**  
44X30cm



**Ref:1111**  
39x39



**Ref:1190**  
45x45cm

# FORMA VACUUM FORM



**Ref:1130**  
43x19cm

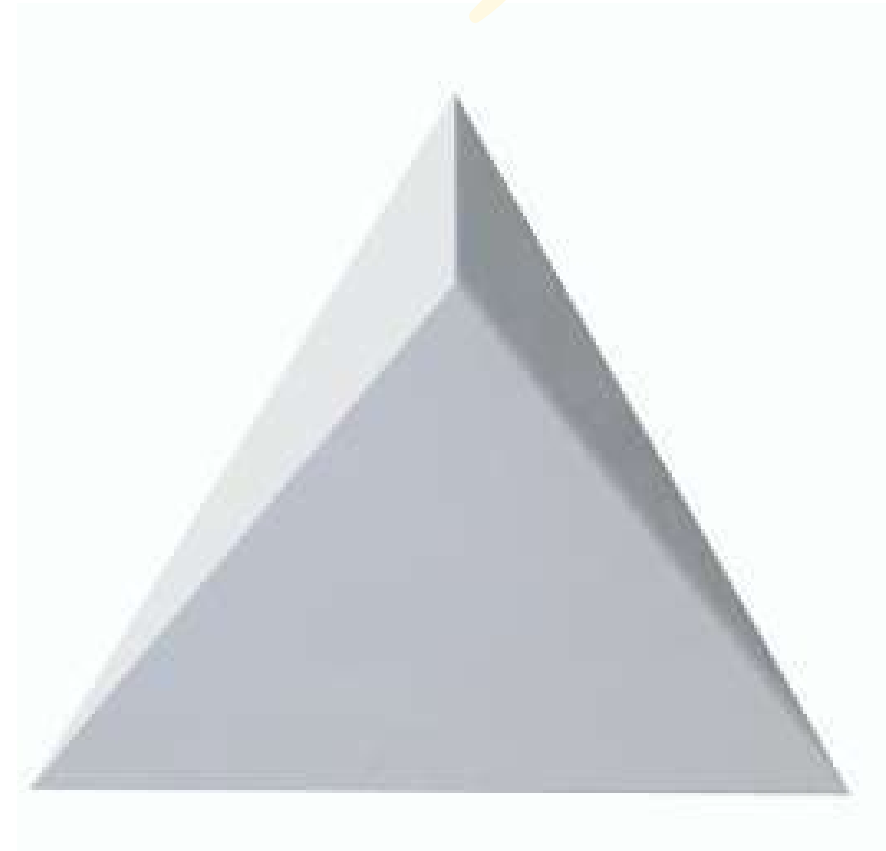

**Ref:0156**  
40x40cm

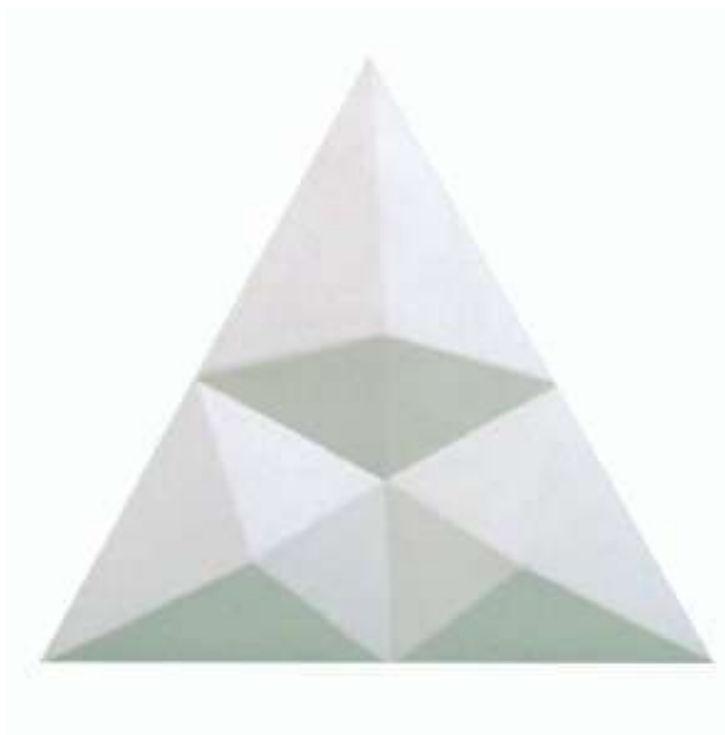

**Ref:0161**  
39x39cm

# FORMA PLÁSTICA INJETADA



14 cm

60 cm



**Ref:191**

60X14X14cm



# FORMA VACUUM FORM



**Ref:20002**  
33x10cm



**Ref:CU0010**  
43x26cm



**Ref:20001**  
40,5x10x28,5cm



**Ref:20003**  
40x25x10cm



**Ref: CU0005**  
45x35x9cm



**Ref:20009**  
39x30x11cm

# FORMA VACUUM FORM



**Ref:20012**  
41x33x14cm

# RIPADO

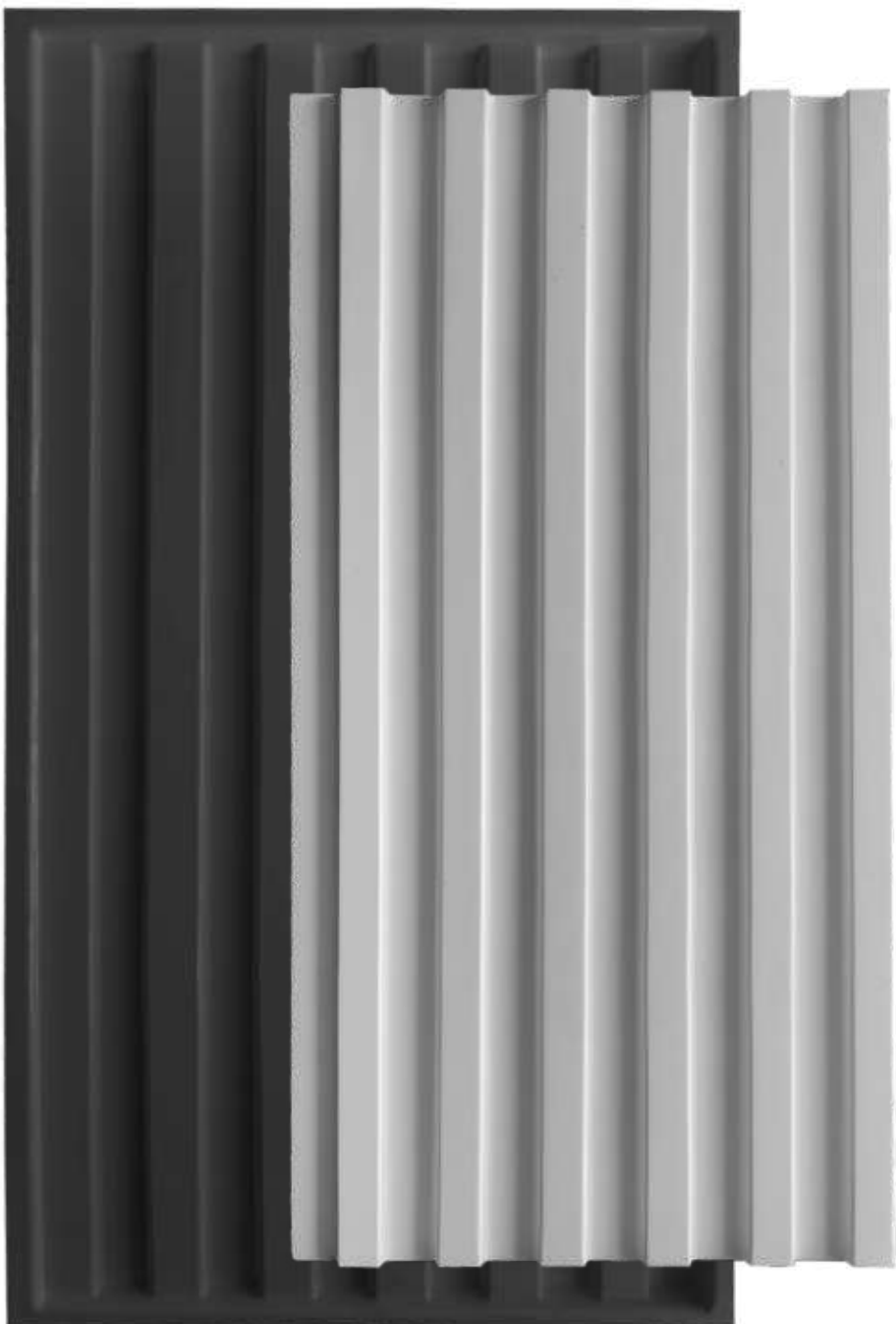

**Ref: 0239**

Medidas :

100 cm de comprimento x 50 cm de largura

1,5 cm base

1,5 cm relevo

distância entre ripas: 4,5 cm



**Ref:0181 - 59x41cm**



**0284 - 50x50cm**

# VASOS



**0728 - 60x17,5cm**



**0727 - 60x17,5cm**



**0701 - 22x43cm**



**0708- 10x10cm**



**0709 - 09x10cm**



**0723 - 58x37cm**



**0724 - 58x37cm**



**0725 - 58x37cm**



**0731 - 74x56cm**

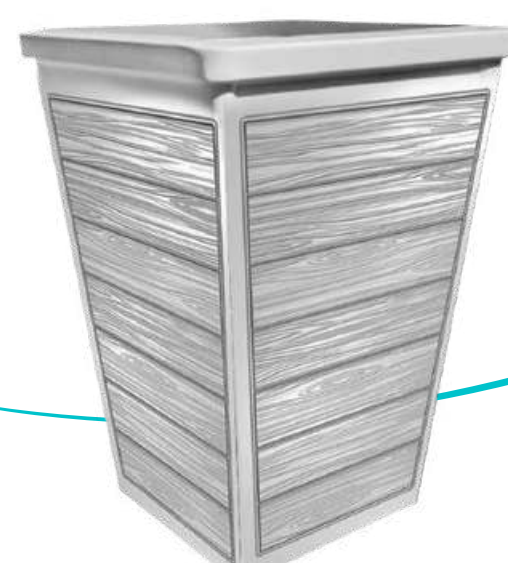

**0735 - 58x37cm**

# GABARITO PARA FAZER VASOS DE CIMENTO COM GUIA E MASTRO

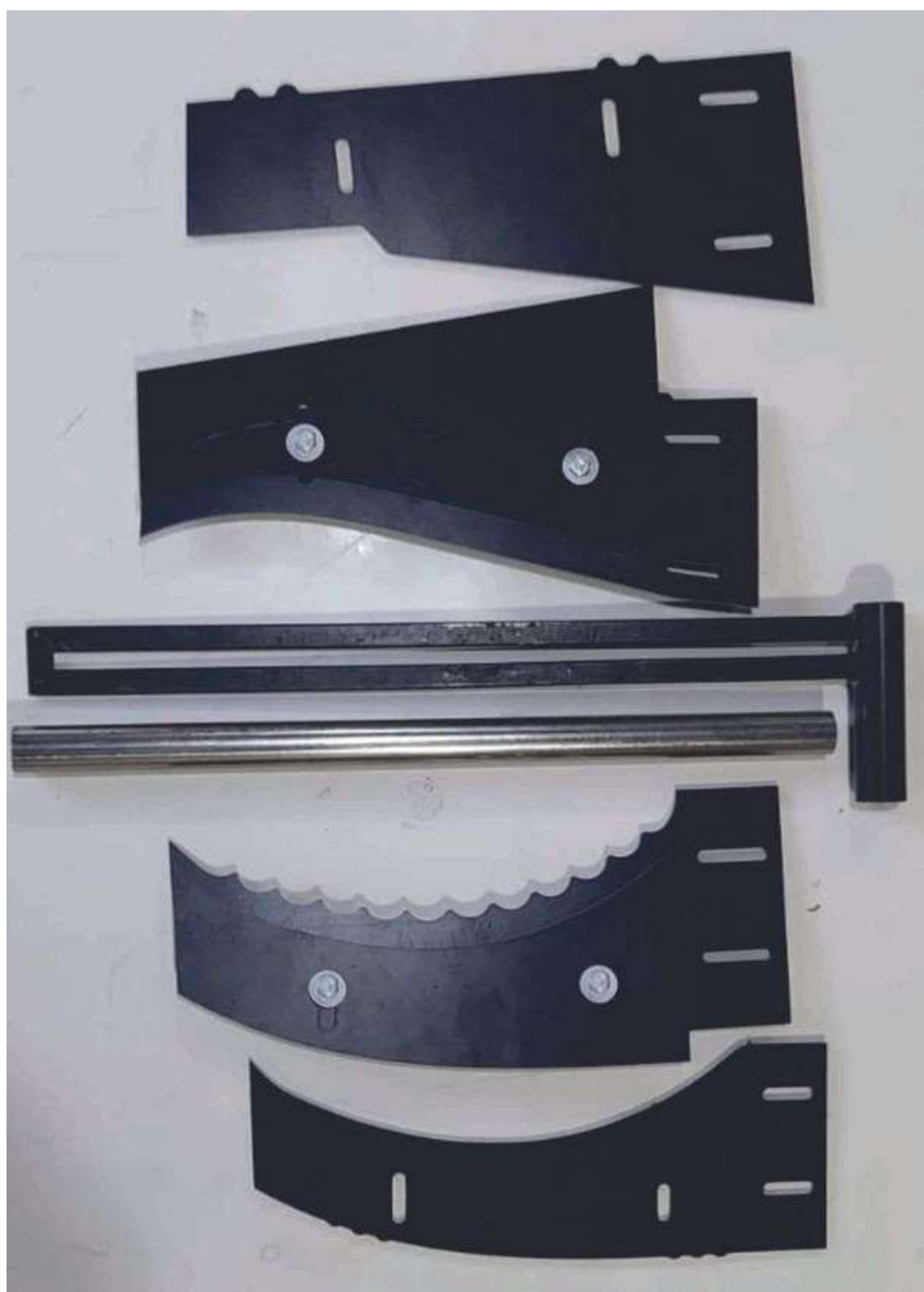

**Inclui: 1 guia em aço de 40 cm de recorrido, 1 mastro de aço de 40 cm, 6 gabaritos para fabricação de vasos de 25 cm de altura.**

**Os gabaritos podem ser usados em ambos lados, estes são de plástico 3 mm de cortado em router cnc.**

# PEÇAS TÉCNICAS



## PORTA ISCAS

26x18x8cm

NF 66



## Coroinha P

NF 109



## Coroinha G

NF 108



# PEÇAS TÉCNICAS

## TAPETE MULTI USO

NF 75

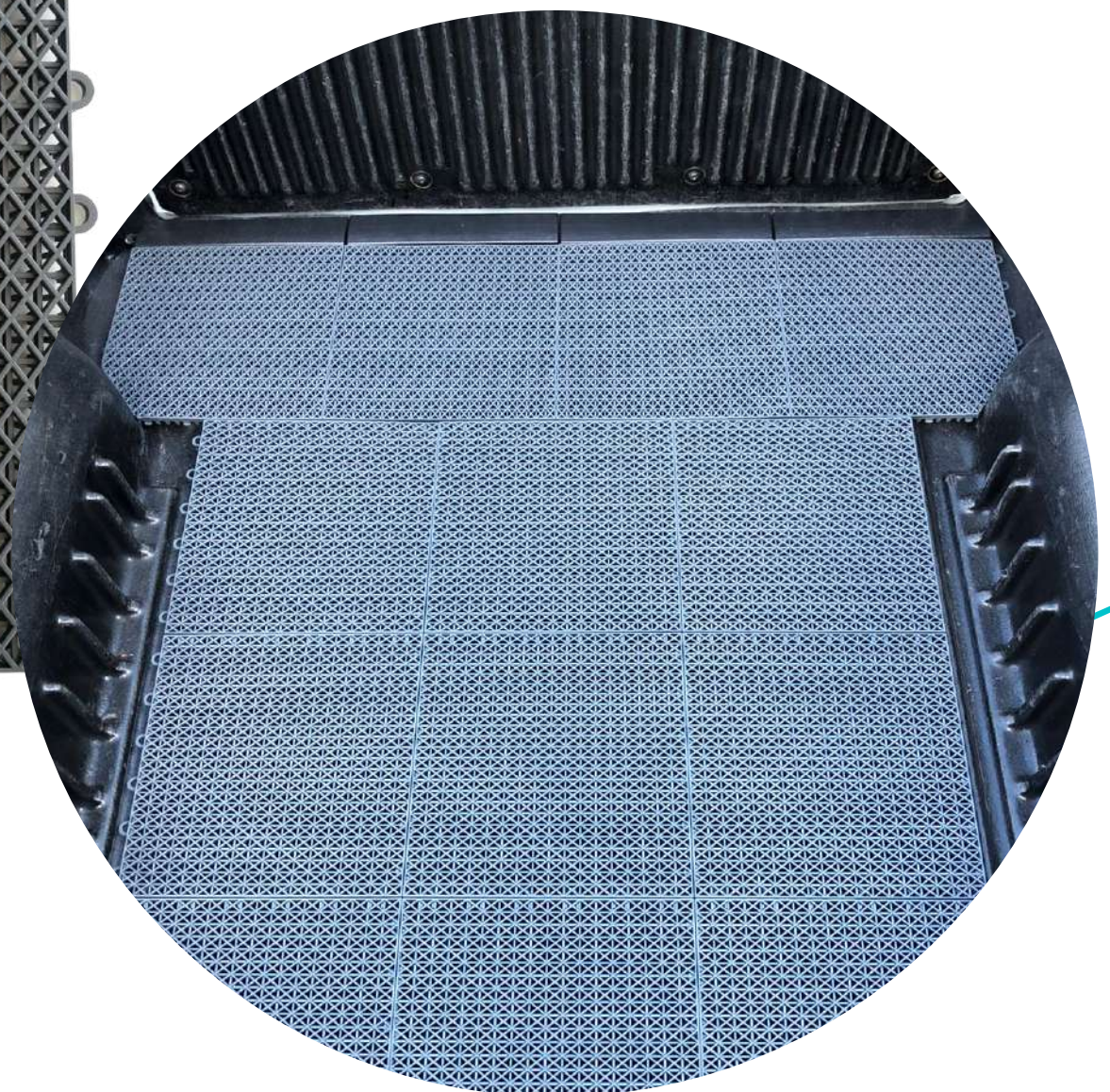
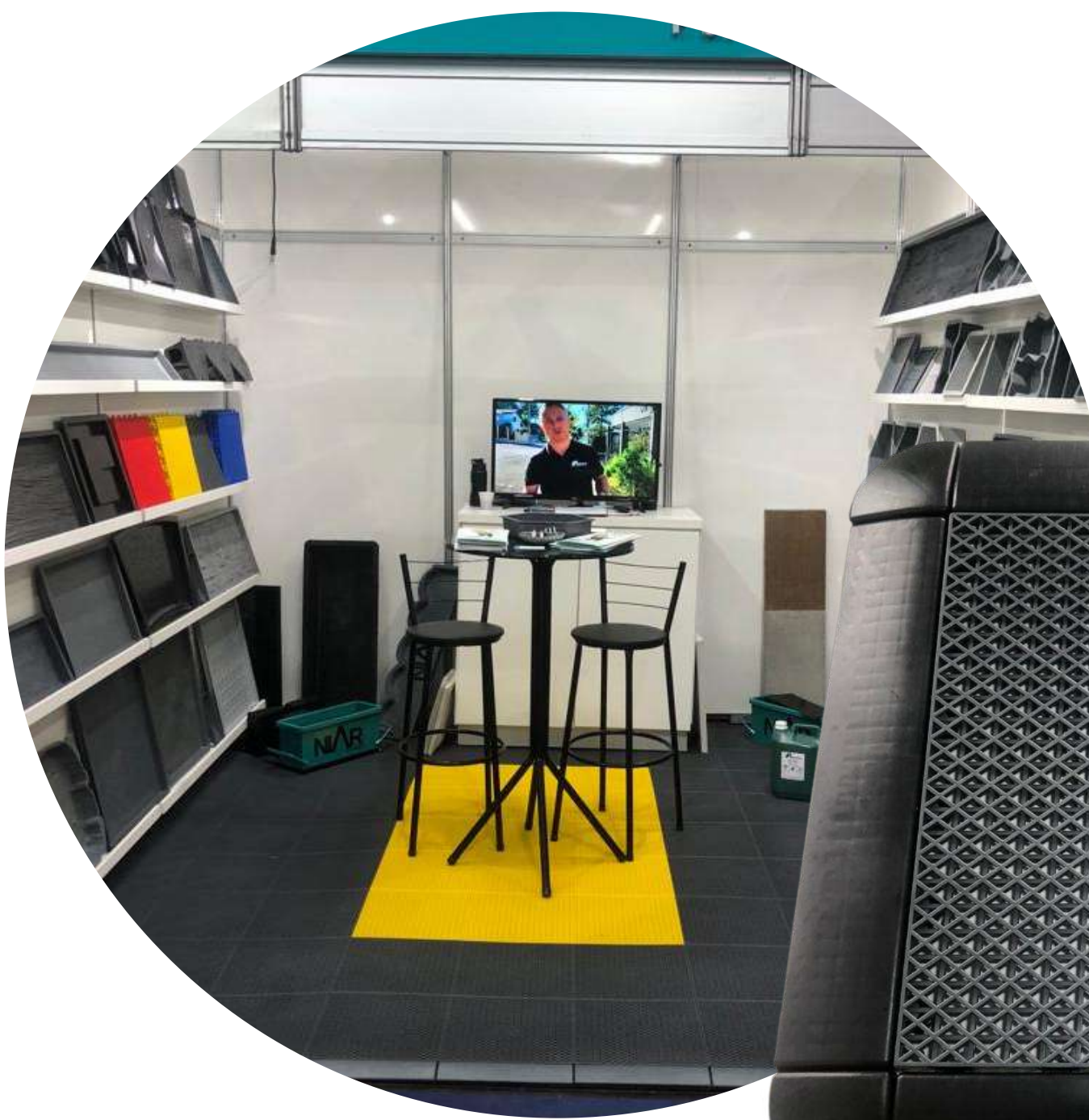

# PEÇAS TÉCNICAS

## Suporte de Borracha

NF 112



## Pé de Bengala

NF 65



## Braço de cadeira

NF 101



## Pé de Cadeira

NF 110



## Pé de Móveis

NF 96



## Pé de Cama/Mesa

NF 54

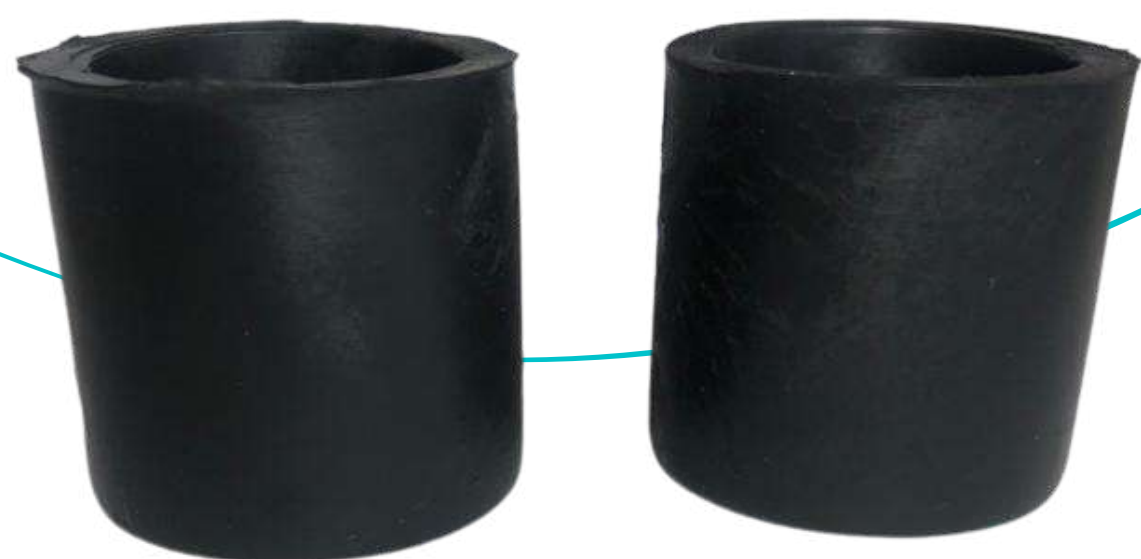



# PEÇAS TÉCNICAS

## Bumerangue

NF 106



## Suporte Celular 2x1

NF 90



## Chaveiro

NF 107



## Mesinha de Pizza

NF 101



## Raspador de Parafina

NF 99



## Removedor de carrapato

NF 68

